



ELECRAFT® KX2

POCKET-SIZED, 80-10 M SSB/CW/DATA TRANSCEIVER

OWNER'S MANUAL

Rev. A5, May 28, 2016

© 2016, Elecraft, Inc.

All Rights Reserved

Contents

Introduction 4

Key to Symbols and Text Styles 4

Installation 5

Operating Position 5

Power Supply 5

Internal Battery 6

Utility Mounting Points (Bottom Cover) 7

CW Key/Keyer Paddle 8

Headphones and Speakers 8

Internal Microphone 8

External Microphone 8

Computer/Amp Keying (ACC) 9

Auxiliary Outputs (AUX) 9

Program/Test (PGM) 9

Antennas 10

Control Panel Reference 12

Display (LCD) 13

Basic Operation 14

Getting Started 14

Band Selection 15

Mode Selection 15

VFO A and B 16

Incremental Tuning (RIT and XIT) 16

Special VFO B Displays 16

Receive Settings 17

Transmit Settings 19

SSB Mode 20

CW Mode 21

Advanced Operating Features 23

Special VFO B Displays 23

Frequency Memories 24

Scanning 24

Audio Effects 25

Dual Watch 25

Programmable Function Switch (PFn) 25

Receive Audio Equalization (RX EQ) 26

Transmit Audio Equalization (TX EQ) 26

SSB/CW VFO Offset 26

Data Modes 27

Text Decode And Display 29

Split Operation 29

Digital Voice Recorder (DVR) 30

Transmit Noise Gate 30

Cross-Mode Operation 30

Custom Power-On Banner 30

Transverter Bands 31

Options and Accessories 32

Firmware Upgrades 33

Remote Control of the KX2 34

Configuration 35

Option Module Enables 35

Menu Settings 35

Calibration 37

Reference Frequency 37

Receive Opposite Sideband 38
Transmit Bias 38
Transmit Gain 38
Transmit Carrier 39
Transmit Opposite Sideband 39

Menu Functions 40

Troubleshooting 52

Parameter Initialization (EEINIT) 56
Error Messages (ERR nnn) 57

Theory Of Operation 60

Glossary of Selected Terms 63

Specifications 65

Customer Service and Support 67

Index 69

Introduction

The Elecraft KX2 is a pocket-sized, 80-10 m, SSB/CW/data transceiver designed specifically for portable, mobile, and hand-held operation. Weighing just 13 oz. (0.35 kg), it's the perfect “grab and go” HF radio.

Despite its small size, the KX2 is a full-featured HF transceiver, with up to 10 watts output. Its powerful digital signal processor (DSP) provides dual watch, built-in PSK and RTTY modes, digital voice recorder, stereo audio, noise reduction, and a wide range of filtering functions. The KX2 can be configured as a complete station, with internal antenna tuner (ATU), attached CW keyer paddle, and an internal battery (KXBT2). Current drain is typically about 150 mA, far lower than other DSP-based portable transceivers.

Since the KX2 is a software-defined-radio (SDR), you'll be able to add new features via free firmware upgrades. For mobile and home use, you can boost the KX2's output to 100 watts with the optional KXPA100 amplifier. The KXIO2 option adds a real-time clock, as well as two outputs that can be used for antenna switching or other applications.

When your next adventure begins—whether at home or in the field—your KX2 will be ready.

73,

Wayne, N6KR

Eric, WA6HHQ

Key to Symbols and Text Styles



Important – read carefully



Operating tip

LSB

Icon or text shown on the display



Enter keypad function



Locked (VFO or menu parameter)

XMIT

Tap function of a knob or switch

TUNE

Hold function (hold switch 0.5 s)

 **MIC**

Rotary control (knob) function

BKLIGHT

Menu entry

Installation

⚠ CAUTION

- **Be careful when plugging in cables.** Avoid sideways pressure that might damage the jacks.
- **Avoid direct exposure to rain or snow** (the KX2 is not waterproof).
- **Avoid operating at very high temperatures.**
- **Prior to opening the enclosure,** touch a grounded, unpainted metal surface to avoid static discharge.

Operating Position

As shown below, the tilt leg on the back of the KX2 can be used to optimize the viewing angle. Loosen the rear thumbscrew to adjust the tilt leg. The KX2 can also be operated hand-held, either vertically or horizontally.

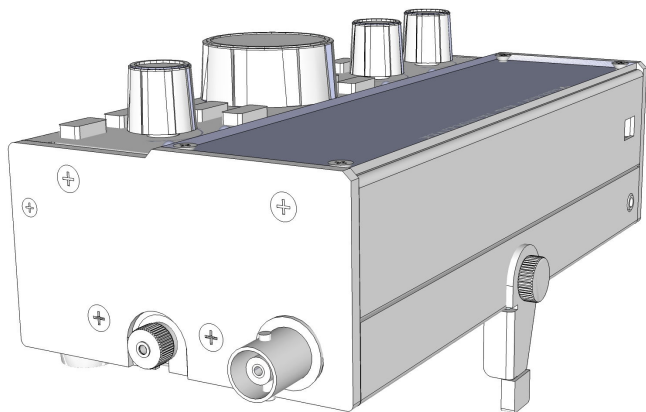

Power Supply

For fixed-station use, a low-noise 12-14 VDC power supply or battery is recommended. For lightweight portable operation, an internal battery can be used.

⚠ See next page for internal battery installation.

Batteries or power supplies can be plugged in from inside, outside, or both. The internal and external DC jacks are identical, and are diode-isolated from each other. This means that the jack having the higher voltage will power the transceiver.

⚠ Power output varies with supply voltage.



An external power supply or battery can be connected to the **9-15 V** jack on the left side panel (see above). **The center pin is (+).** The plug can be a Switchcraft model S760 or similar (2.1 mm aperture, 5.5 mm dia.). **The white striped wire on the supplied cable is (+).** Trim the cable to the desired length.

Internal Battery

The battery compartment accepts our model KXBT2 lithium-ion pack. This is an 11 V, 2.6 Ah battery with protective circuitry.

Battery installation:

- Loosen the two thumb nuts at the ends of the bottom cover; lift the cover off. **Do not pull on the speaker wires.**
- Place the battery as shown and plug it into the internal jack.
- Make sure battery wires are tucked inside, beside the plug.
- Install the bottom cover.
- **Tighten the two thumb nuts firmly to keep the bottom cover in place.**

Battery removal:

- Open the bottom cover as described above.
- Pull the battery plug out slowly, **using the provided nylon pull-loop. Do not pull on the battery pack wires.**
- Replace the bottom cover and tighten the thumb nuts firmly.

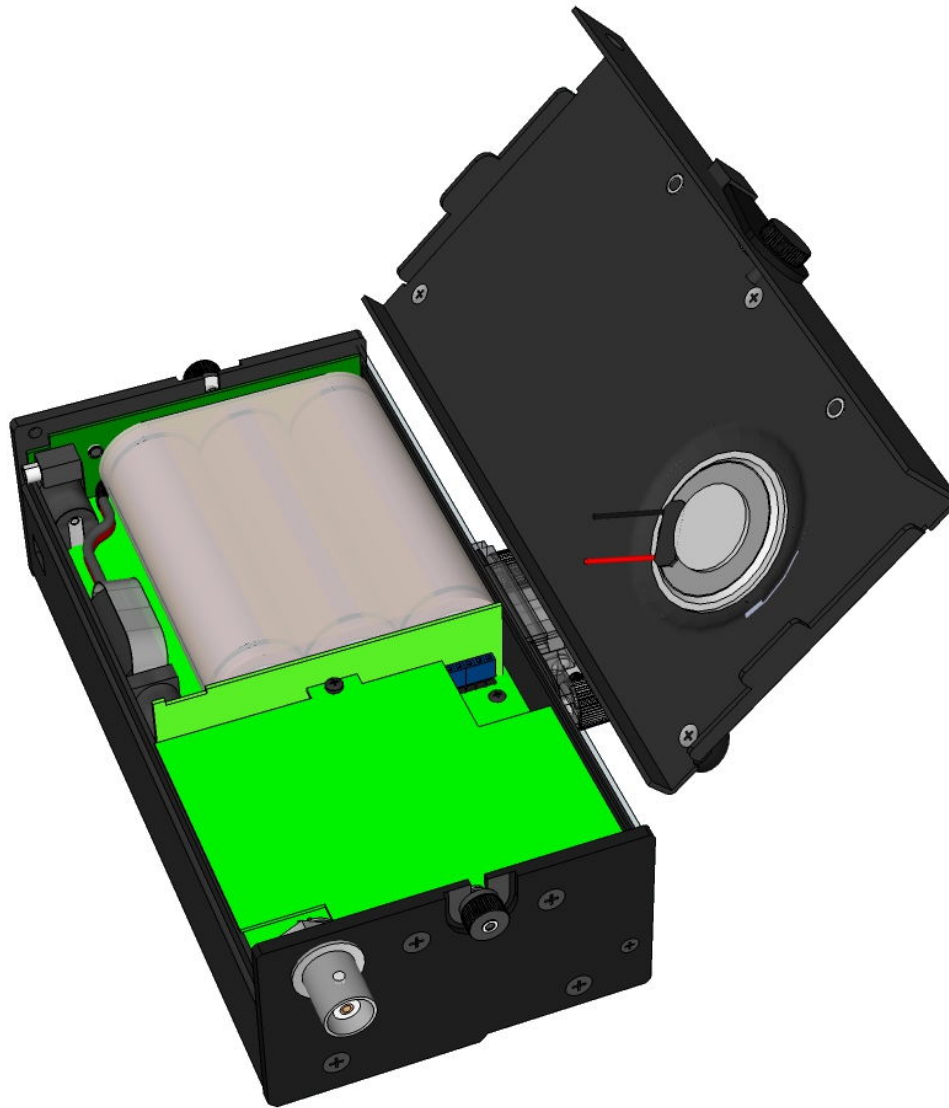

Using the Battery Safely

⚠ Misusing a lithium-ion battery may cause it to get hot, rupture, or ignite and cause serious injury; or result in loss of performance and shortened life.

The KXBT2 battery pack weighs only 4.8 oz, and can provide up to 8 hours of typical transceiver operation and up to 10 W power output. **To ensure safe operation, please take a moment to read the information sheet supplied with the battery.**

The pack is fitted with a 2.1 mm DC barrel plug. The KX2 has two DC barrel jacks: one inside, and one on the left side panel. These jacks are isolated from each other, but either can power the KX2. You can plug in an internal battery *and* an external supply, and the radio will operate from whichever is higher in voltage.

Battery Charging

⚠ The battery must be charged using only the matching KXBC2 smart-charger.

To charge the battery, you must first remove it as described on the previous page. **It cannot be charged while inside the KX2.** The power jack on the left side panel is isolated from the internal power jack, and cannot supply power to the battery.

Plug the battery into the jack on the charger, then plug the charger into a 120 VAC outlet. The charger's LED will be red during charging, and GREEN when charge is complete. A full charge cycle typically takes 1 to 2 hours depending on the state of charge.

Amp Hour Metering

The KX2 includes an amp hour meter function that allows you to better estimate remaining battery life. See pg. 16 for the associated special display function, as well as the *AMP HRS* menu entry.

Preserving Clock Time During Charging

The KXIO2 option module includes a real-time clock (RTC). RTC circuitry is powered by the battery or power supply connected to the KX2 (internal or external).

When no power supply or battery is connected, the RTC's time registers are preserved for up to 2 hours by a *supercapacitor* on the KXIO2. In most cases this allows sufficient time to remove the battery from the KX2, charge it, and reinstall it without losing the time setting.

Utility Mounting Points (Bottom Cover)

The KX2's bottom cover has two threaded fasteners (4-40 PEM nuts) for light-duty applications. For example, they could be used to attach the transceiver to a clipboard for field logging, or for storage of a counterpoise wire (see pg. 10, right column).

⚠ CAUTION: These fasteners are not intended for use with a mobile mount. Also, do not allow screws or other hardware to protrude more than 0.1" into the interior of the KX2.

CW Key/Keyer Paddle

The KX2 has two CW keying inputs:

Attached Keyer Paddle: An Elecraft KXPD2 (or KXPD3) keyer paddle can be attached at the front of the KX2 via two thumb screws. Use the *CW KEY2* menu entry to reverse the dot/dash sides.

KEY Jack: This jack can be used with any hand key, keyer paddle, or other keying device, as configured by the *CW KEY1* menu entry.

⚠ A stereo plug is required at the KEY jack, even if only the tip contact is being used.

Headphones and Speakers

The 3.5 mm **PHONES** jack accommodates headphones or one or two externally amplified speakers. Mono or stereo plugs can be used. Stereo audio allows the use of *dual watch* and *audio effects* (pg. 25).

Built-In Speaker: The speaker, located on the bottom cover, sounds best when the tilt foot is used.

i Headphones or external speakers will provide greater bass response than the internal speaker.

Mobile installations: For mobile use, amplified mobile speakers or an aux input on your car's stereo can be connected to the **PHONES** jack. Another alternative is to use a device that retransmits the KX2's audio output in the FM broadcast band.

Internal Microphone

For emergency or hand-held use, the KX2 includes a built-in mic, located to the left of the AF/MON control. (There's a small hole in the panel at this location.) The built-in mic is automatically turned on when no external mic is plugged in. Tap **XMIT** to transmit.

⚠ To prevent acoustic feedback, the transmit voice monitor function (MON) is disabled when using the internal mic with the internal speaker.

External Microphone

The 3.5 mm **MIC** jack is compatible with the Elecraft MH3 hand mic, which provides PTT as well as VFO UP/DN buttons. For the MH3, set the *MIC BIAS* menu entry to **ON**, and *MIC BTN* to **PTT UP.DN**.



MIC Jack Pinout

Sleeve: Shield ground

Ring2: Logic ground

Ring1: PTT/UP/DN

Tip: Mic audio

The KX2 will work with many other mics, including “mini” mics intended to plug directly into a computer. Refer to the *MIC BIAS* and *MIC BTN* menu entries to set up the KX2 for use with your mic or headset.

Computer/Amp Keying (ACC)

The 3.5 mm accessory jack (ACC) facilitates firmware updates and remote control of the KX2 via a computer, and/or connection to an Elecraft KXPA100 amp. In either case, a standard stereo plug can be used (see *sleeve*, *ring 1*, and *tip* connections below). The supplied **KXUSB** cable can be used for this purpose.



ACC Jack Pinout

Sleeve: Ground

Ring 2: *Key Out

Ring 1: TX Data

Tip: RX Data

* For external amplifier keying, the ACC jack's *key out* signal (on *Ring 2*) may also be needed, as described at right. In this case a 4-circuit (TRRS) plug is required.

Computer Applications

KX2 Utility is required for firmware configuration and updates (pg. 33). The utility program also provides a CW/data terminal function. Our **Elecraft Frequency Memory Editor** can be used to set up frequency memories.

Many logging, contesting, and control programs are available from third parties. If the KX2 is not specifically supported, try using **Elecraft KX3** or **K3**.

Amplifier Keying

The ACC jack provides a *key out* signal (*Ring 2* contact, shown at left). *Key out* goes low during transmit, and can be used for transmit/receive switching of linear amplifiers and transverters. For keyline voltage and current limits, see **Specifications**.

⚠ If the *key out* signal is not required, a regular stereo plug can be used (3-circuit). This will short the key out signal to the sleeve (ground), but will not cause any damage or consume additional current.

An **Elecraft KX2 Accessory Cable** (KX2ACBL) can be used to break out the computer control and *key out* signals separately. These can then be connected to both an Elecraft KXPA100 amplifier via its supplied cable.

Auxiliary Outputs (AUX)

If the KX2 is fitted with a KXIO2 (pg. 32), then a 2.5 mm **AUX** jack will be available. This jack provides two general-purpose outputs that can be programmed on a per-band basis to control equipment such as an antenna switch or transverter. On the connector, the *sleeve* is ground, *tip* is AUX 1, and *ring* is AUX 2.

Program/Test (PGM)

This jack is reserved for Elecraft factory test use.

Antennas

General information on antennas can be found on the next page. Here, we show two examples of antennas for portable operation that can be set up quickly.

The illustration at left shows a simple wire antenna connected to a KX2 via a BNC-to-binding post adapter (Elecraft BNC-BP or equivalent). The wire tied to the red post (antenna hot lead) is attached to a tree or other tall support. The wire tied to the black post (radio chassis ground) is the equally important *counterpoise*, which is typically laid on the ground.

A length of about 25 feet for each wire, matched to the KX2's output using an antenna tuner (see ATU, pg. 11) will typically provide good performance on 40-10 m. (Without an ATU, resonant lengths are required for each band.) This antenna is ideal for outings where all gear must fit into a small bag (e.g. our model CS-40).

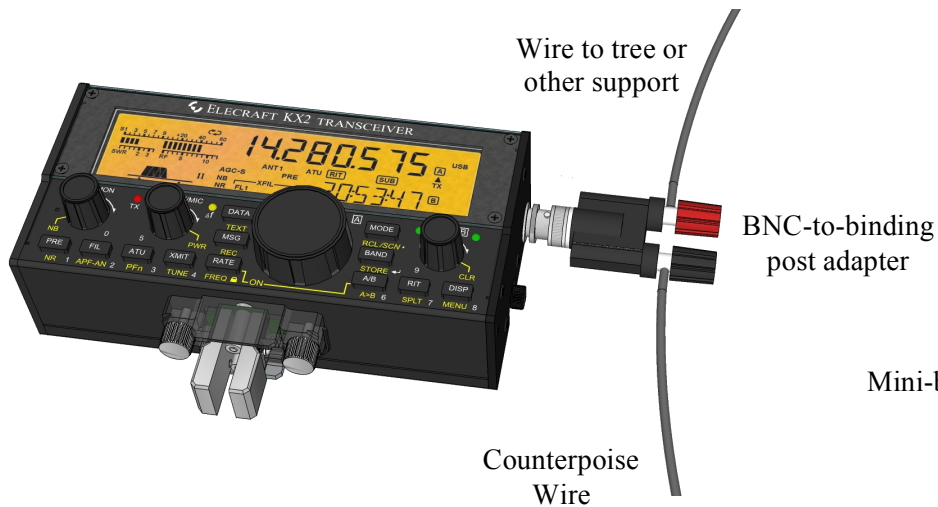

At right, a KX2 is shown in hand-held orientation with a telescoping whip antenna. MFJ 18xxT series whips or similar are recommended.

(Such antennas are electrically short, making contacts more challenging. Best results will be obtained on 20 meters and higher.)

When using a whip antenna, you'll also need a counterpoise wire, shown here attached via a mini-banana plug (Elecraft model KX2GNDPLUG). A length of about 13 feet is a good compromise for 20-10 meters. This is sometimes called a "trailing ground" by those who operate *pedestrian mobile* (/PM). If you step on the counterpoise wire, or get it snagged, the mini-banana plug will pull out safely, avoiding damage to the KX2.

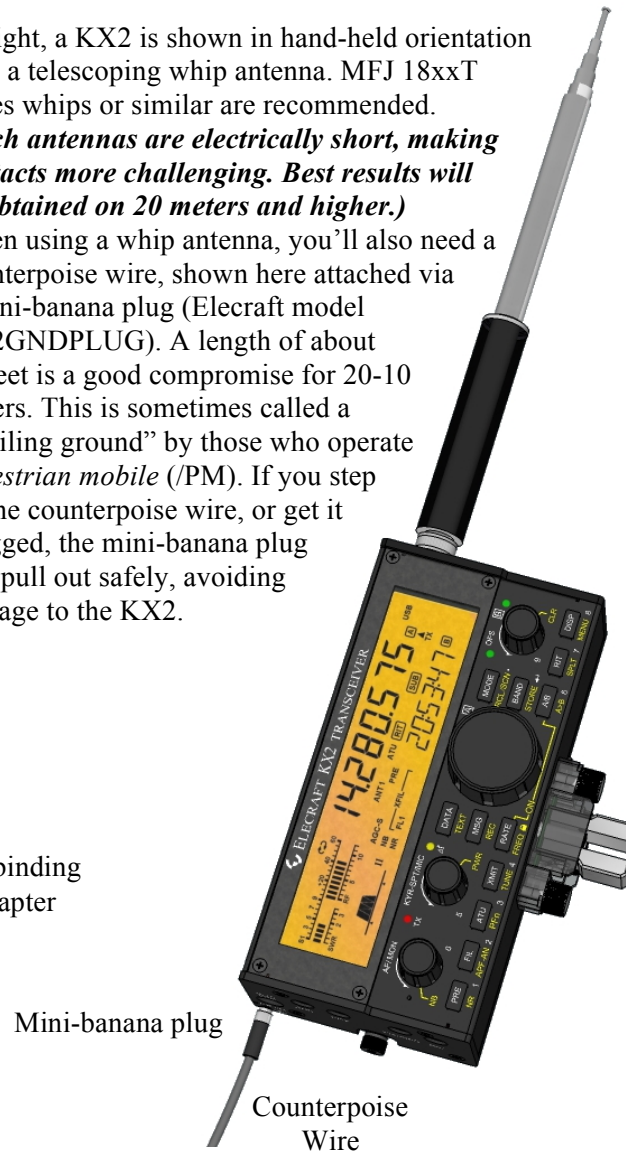

General Antenna Information

An antenna must be connected to the BNC jack on the right side panel, via either coax or an adapter. If an antenna tuner is not used (either an external tuner or an internal KXAT2), then a resonant antenna having a 50 ohm (approximate) load impedance on each band of operation is required. Examples can be found in the *ARRL Antenna Handbook* and other sources. A coax-fed inverted “V” or dipole can be very effective.

SWR: One measure of how close an antenna is to resonance is its *SWR* (standing wave ratio). The KX2 displays SWR when you use the **TUNE** switch (pg. 19). An SWR of 1:1 (**1.0-1** on the KX2’s display) is considered a “perfect” match. To ensure safe operation, the KX2 reduces power output if SWR is too high.

Using An Automatic Antenna Tuner (ATU): An ATU will allow the KX2 to “see” a good match in many cases (i.e., a low SWR) even with non-resonant antennas. This allows the transmitter to deliver full power, and can improve receiver sensitivity. An ATU may allow one antenna to be used on multiple bands.

You can use an external or internal ATU. The KXAT2 (the KX2’s internal ATU option, pg. 32), stores matching information for each band, so that retuning takes less than 1 second.

Antenna Wire: Insulated, stranded wire works well for portable antennas. We recommend #26 “Silky” from The Wireman (catalog #534). To avoid kinks, wire can be wound in a figure-8 pattern. For tossing wire into tree branches, attach a 1 to 2 oz. weight (such as stainless-steel hex nut) to the end of the wire.

Feedline: When using low power, antennas can often be directly connected to the KX2 without any coax or other feedline. This is shown in both of the simple portable antennas on the previous page. However, balanced antennas such as dipoles and inverted Vs will function better when their feed point is physically well above ground.

Resonant antennas (those which are cut to length for a given frequency) are typically fed with 50 ohm coax. RG-174 is a good choice when light weight is required. Random-length antennas can be fed with twin-lead, then connected to a *balun* (balanced-to-unbalanced converter), such as the Elecraft BL1 or BL2. The balun can then be connected directly to the transceiver (if an internal ATU is used) or to an external ATU.

Ground and Counterpoise Systems: A ground or *counterpoise* is needed with many antennas. The *ARRL Antenna Book* provides examples. This is definitely needed when you use a whip, vertical, or random wire.

The ground or counterpoise can be connected to the KX2 via the bottom cover thumb nuts or to the outer shield of the BNC jack. There’s also a hole in the left side panel, identified by a ground symbol, that is sized for a mini-banana plug. This is ideal for a quick-disconnect *trailing ground wire* used during pedestrian mobile operation. See example on previous page.

For improved performance, use at least one 1/4-wavelength radial for each band when possible. Adding more radials on a given band will further reduce losses, especially when transmitting.

Control Panel Reference

(For details, refer to page numbers shown in parentheses)

Power ON/OFF: Hold both the **RATE** and **A/B** switches for 2 seconds (see “ON” label below the VFO A knob).

Tap / Hold Functions, e.g. **PRE** / **NR:** Tap to use the function labeled on or above a control; hold ½-sec for the function labeled below it.

Numeric Keypad: Twelve of the switches and knobs form a keypad (0-9/decimal/enter) for use with **FREQ**, etc.



Receive

- ⊖ **AF/MON** AF gain (17); tone/monitor level (17)
- ⊖ **NB** Noise blanker (18)
- PRE** Preamp / attenuator (17)
- NR** Noise reduction (18)
- ⊖ **FIL** / **APF-AN** Filtering (17); APF (18); auto-notch (18)

Transmit

- ⊖ **KYR-SPT/MIC** Keyer (19); Spot (21); Mic gain (19)
- ⊖ **PWR** Power level (19)
- ATU** ATU tune (19)
- PFn** Programmable switch (25)
- XMIT** TX/PTT (19)
- TUNE** CW carrier (19)

VFO A / Band / Mode

- DATA** Data mode (27)
- TEXT** Text decode (29)
- MSG** Msg play (19, 30)
- REC** Msg record (19, 30)
- RATE** VFO tuning (16); ON/OFF (with **A/B**)
- FREQ** Freq. entry (15)
- MODE** CW/SSB (15)
- RCL/SCN** F. recall (24), Scanning (24)
- BAND** Band (15)
- STORE** F. store (24)
- A / B** A/B swap (16)
- A > B** A>B copy (16)

VFO B / Misc.

- ⊖ **OFS/B** Coarse VFO tuning (16); VFO B (16)
- CLR** Clear RIT (16)
- RIT** Receive offset (16)
- SPLIT** Split RX/TX (29)
- DISP** Special disp. (23)
- MENU** Menu (14)

Display (LCD)

(For Details, refer to page numbers shown in parentheses)

RX: S-meter and CW tuning aid (18);

TX: SWR/RF output or compression/ALC (19)

VFO Icons:  Shows that a VFO is locked.

TX icon points to the transmit VFO, A or B (29).

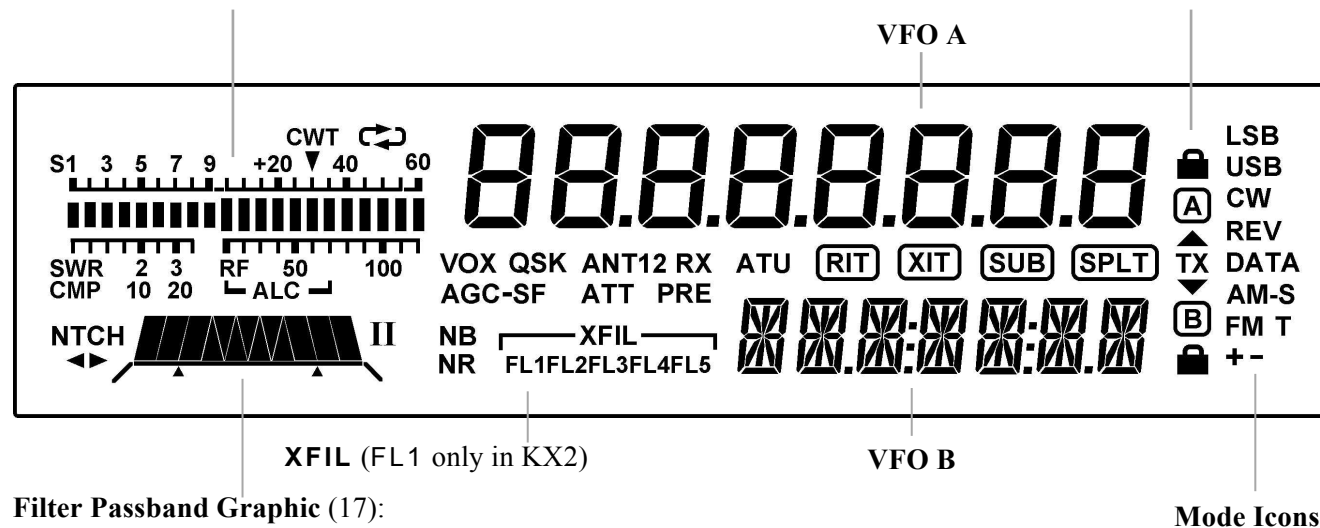

Filter Passband Graphic (17):

NTCH Auto-notch (18); **I/II** (not used)

Other icons:

CWT CW/data tuning aid on (*MENU:CWT*, 18)

 Message play/rec (*MSG* / *REC*, 19, 30)

VOX VOX enabled (*MENU:VOX MD*, 20, 21)

QSK Full break-in CW (*MENU:VOX DLY*, 21)

NB Noise blanker on (*NB*, 18)

NR Noise reduction on (*NR*, 18)

ANT KXPA100 antenna (19)

RX Automatic RX attenuation in effect (17)

ATT Attenuator on (*PRE*, 17)

PRE Preamp on (*PRE*, 17)

ATU ATU enabled (*ATU*, 19)

RIT RIT on (*RIT*, 16)

XIT XIT on (*MENU:XIT*, 16)

SUB Dual-watch enabled (*MENU:DUAL RX*, 25)

SPLT Split mode in effect (*SPLIT*, 29)

Basic Operation

This section describes basic KX2 features. Once you've mastered these, you'll be ready to explore **Advanced Operating Features** (pg. 23) including built-in text decode, memories, and dual watch.

Getting Started

Before using the KX2, you'll need to connect a power supply and an antenna. See **Installation** (pg. 5).

Turning the KX2 On/Off

To turn the KX2 on or off, press and hold the **RATE** and **A/B** switches simultaneously for about two seconds, then release. The switches are identified by an "ON" label below the large knob (VFO A). This dual-switch power on/off method reduces the likelihood of accidental power-on in a backpack or carrying case.

⚠ Always turn the KX2 off as described above before turning off or disconnecting the power source. This will ensure that settings are saved.

Switch **TAP** and **HOLD** Functions

All KX2 switches have two functions:

- **Tap** to activate the function labeled *on* a switch, e.g. **RATE**
- **Hold** for about 0.5 second to activate the function labeled *below* a switch, e.g. **FREQ**

AF Gain and other Knob Functions

Each small knob has two primary functions. For example, **AF/MON** normally controls receiver **AF gain**. The setting is displayed in the VFO B area during knob rotation. **Tapping** this knob briefly switches to the **MON** function (sidetone or voice monitor level). **Holding** the knob—pushing it for over 0.5 seconds—switches to its secondary function, **NB** (pg. 18).

Knobs may also be used in conjunction with nearby switches. For example, if you tap **DISP**, rotating **OFS/B** selects special VFO B displays (pg. 23).

Using the Configuration Menu

To access the menu, hold **MENU** until the **BKLIGHT** (LCD brightness) menu entry appears in the VFO B area. The setting appears in the VFO A area.

To change a setting, rotate VFO A (large knob). In the case of **BKLIGHT**, this selects backlight **ON** or **OFF**.

To scroll through menu entries, use the small knob above the menu switch, **OFS/B**. **To exit the menu**, tap **DISP**.

i While in the menu, holding **MENU** for ~3 seconds displays information about the current menu entry.

Configuration and Calibration Functions

Once you've mastered the menu, you should review your KX2's **Configuration** settings (pg. 35). The menu is also used for factory **Calibration** (pg.37).

Band Selection

The KX2 transmits and receives in the 80-10 m amateur bands. It also provides general coverage receive from 0.5 to 32 MHz, which includes the AM broadcast band and 160 m. AM signals can be copied using SSB modes. (Sensitivity and image rejection are reduced below 3 MHz; see **Specifications**, pg. 65.)

Characteristics of each amateur band are briefly summarized below. For further information, see the ARRL *band plan* (www.arrl.org/band-plan-1).

To change bands: Tap **BAND**, rotate the VFO A knob to select the desired band, then tap any switch to exit. You can also change bands using direct frequency entry (described at right) and memory recall (pg. 24).

Band (m)	Range (MHz)	Best DX	Other Characteristics
160	1.8-2.0 (RX only)	Night	Challenging "Top Band"; high power often used to counter noise
80	3.5-4.0	Night	Excellent regional band; many CW and SSB nets; AM ~3.870
60	~5.3-5.4	Night	Shared with government services; power level and modes restricted
40	7.0-7.3	Night	Excellent local CW/SSB band by day; QRP & data modes, 7.03-7.04
30	10.0-10.15	Both	DX possible anytime; no contests
20	14.0-14.35	Both	Very popular DX & contest band; many nets on SSB; Data modes: PSK ~14.070; RTTY ~14.085
17	18.068-18.168	Day	Long-haul DX band; no contests; "HF Pack" at 18.1575 (often QRP)
15	21.0-21.45	Day	DX/contest band; low power very effective when band is open
12	24.89-24.99	Day	Excellent DX band; no contests
10	28.0-29.7	Day	Great QRP DX band; CW beacons (28.2-28.3) show if band is open

Direct Frequency Entry

A subset of the controls functions as a numeric keypad for use with **FREQ**. See white secondary switch and knob labels **0 - 9**, decimal point, and *enter* (↵).

First, hold **FREQ**. Then enter one or two **MHz** digits, optionally followed by a decimal point and up to three **kHz** digits. Next tap **↵** (**BAND**) to accept, or any other switch to cancel. **Examples:**

14.255 MHz: **FREQ** 1 4 . 2 5 5 **↵**

7.000 MHz: **FREQ** 7 **↵**

Mode Selection

Tap **MODE** to select SSB or CW mode. Tap **DATA** to select the last-used data mode (pg. 15). To select alternate modes (USB/LSB, CW normal/reverse, or DATA normal/ reverse) use the *ALT MD* menu entry.

SSB (single sideband, pg. 20) is actually two different narrow-band voice modes: LSB (lower sideband) and USB (upper sideband). LSB is normally used on 160, 80, and 40 m, while the other bands normally use USB. AM signals can be copied using either LSB or USB.

CW mode (pg. 21) uses much less bandwidth than SSB, providing a high signal-to-noise ratio ideal for low-power (QRP) operation.

DATA modes (pg. 27) are often used with a computer connected to the KX2 to send/receive text. However, there are also three built-in data modes that use the KX2's display for received text, and a keyer paddle for transmit, converting the CW you send into data.

VFO A and B

The KX2 provides two *VFOs* (see glossary, pg. 63). Each VFO has its own frequency, mode, and filter settings. Use of VFO B (☉ **OFS/B**) is optional.

VFO A normally controls both the receive and transmit frequency. If you use VFO A to tune in a signal clearly, you'll also be on-frequency for transmit.

VFO B can serve as a holding register for a frequency of interest (see **A / B** swap below). It is also used with **SPLIT** (pg. 29) and **Dual Watch** (pg. 25). To tune VFO B, first make sure the **B** LED above the knob is lit. If not, tap the ☉ **OFS/B** knob.

Tuning rates: Tapping **RATE** normally alternates between 10 Hz and coarse-tuning steps (*MENU:VFO CRS*). The default coarse step size for CW is 0.1 kHz, and for SSB, 0.5 kHz. In DATA modes, or when the audio peaking filter is in use in CW mode (APF, pg. 18), **RATE** alternates between 1 Hz and 10 Hz steps.

i ☉ **OFS/B** is used to tune VFO A in coarse steps. For this purpose, the **OFS** LED must be lit (if not, tap the knob), and RIT (see at right) must be turned **off**.

To lock VFO A: Hold **FREQ** for about 3 seconds. Tap **RATE** to unlock. To lock VFO B, first swap it with VFO A, lock A, then swap again.

To copy VFO A's frequency to VFO B: Hold **A > B**. Tap twice to copy mode and filter settings as well.

VFO A and B swap: Tap **A / B** to exchange VFO frequencies, modes, and all other settings.

Incremental Tuning (RIT and XIT)

RIT, or *receive incremental tuning*, adjusts the receive frequency without affecting your transmit frequency. RIT is sometimes called a *clarifier* since it can be used to tune in voice signals clearly. It is also useful in CW and DATA modes when a station calls off-frequency.

XIT, or *transmit incremental tuning*, adjusts the transmit frequency without affecting the receive frequency. (An alternative is to use SPLIT, pg. 29.)

Δ F (Delta-F) LED ●: This LED turns on whenever RIT, XIT, or SPLIT is in use as a reminder that your receive and transmit frequencies may be different.

To use RIT: First, tap **RIT**. This turns on the **RIT** icon and the **OFS** LED. Adjust using ☉ **OFS/B**.

To use XIT: XIT is controlled using *MENU:XIT*. Setting the menu entry to **ON** turns on the **XIT** icon and the **OFS** LED. Adjust using ☉ **OFS/B**.

To zero the RIT/XIT offset: Hold **CLR**.

i You can still use the ☉ **OFS/B** control to tune VFO B, even if RIT or XIT is turned on. Just tap the knob to turn the **B** LED back on. The RIT/XIT icons on the LCD will retain their current states.

Special VFO B Displays

To see special information on VFO B, tap **DISP**, then rotate ☉ **OFS/B**. Available displays include time, supply voltage, supply current, amp hours used, etc. (see pg. 23).

Receive Settings

The **Receive** controls group, which includes the \odot **AF/MON** knob and the two switches below it, is used to set up the KX2's receiver. On the display, directly above these controls, is the *filter passband graphic*. This shows the receiver's audio passband.

AF Gain / Monitor Level Control

The \odot **AF/MON** knob normally controls receiver **AF gain**. Tapping the knob switches its function to **MON** (monitor volume level). In CW mode, this turns on the *sidetone* (also see **Spot**, pg. 21). In SSB mode, you'll hear your microphone audio (pg. 17).

i Switch activation tones, if used, have the same volume level as the CW sidetone (as set in CW mode using \odot **MON**). Switch tones can be set to off, on, or Morse code characters (*MENU:SW TONE*).

Preamp and Attenuator

On successive taps, **PRE** cycles through **preamp on** (attenuator off), **both off**, and **attenuator on** (preamp off). **PRE** and **ATTN** icons are updated accordingly. Typically the preamp is used on the higher bands or with low-gain antennas. If interference is heavy, turn the preamp off, and if necessary, turn the attenuator on.

i You can improve sensitivity by using the internal ATU to resonate the antenna. Tap **ATU**.

i The KX2 will automatically reduce receive gain in the presence of very strong signals. The overload icon (**RX**) will turn on. Also see *MENU:COR LVL*.

Filter Passband Control

Tapping **FIL** places the KX2 in **FIL ADJ** mode. In this mode, the \odot **AF/MON** and \odot **KYR/MIC** knobs can be used to adjust the filter passband as described below. Settings are stored per-mode.

The passband graphic shows an approximation of the width and centering of the current filter. The example below shows a medium-width filter that is centered (not shifted):



In general, a narrow passband reduces interference (QRM) and noise (QRN), while a wider passband can reduce listening fatigue and improve fidelity.

Using FIL ADJ mode:

- Rotate \odot **AF/MON** knob to adjust the filter width.
 - Tap \odot **AF/MON** to *normalize* the filter to the standard per-mode setting. This turns on the two “wings” shown at the left and right ends of the graphic as shown above.
 - Rotate \odot **KYR/MIC** to shift the passband left or right.
 - Tap \odot **KYR/MIC** to center the filter without changing the bandwidth.
 - To exit **FIL ADJ** mode, tap any other switch, key the transmitter, or rotate VFO A.
- i** Filters in the KX2 are implemented entirely within the digital signal processor (DSP).

Noise Reduction

Noise reduction (NR) removes random background noise (hiss or static). It has a characteristic “hollow” sound. Higher settings may attenuate weak signals.

Holding **NR** turns on noise reduction and displays its setting, which can then be adjusted using the knob above the switch. Tap any switch to exit the setting display. Hold **NR** again to turn noise reduction off.

Noise Blanking

Noise blanking can eliminate repetitive noise such as that from power lines, appliances, and vehicle ignition systems. Use the lowest effective setting.

Holding **NB** (a function of the \odot **AF/MON** knob) turns on the noise blanker. The setting can then be adjusted using this knob. Tap any switch to exit the setting display. Hold **NB** again to turn the blanker off.

Audio Peaking Filter (APF) and Notch Filter

In CW mode, holding **APF-AN** turns on a very narrow filter to improve copy of weak CW signals right at the receiver’s noise floor. The filter graphic changes as shown below, and VFO tuning is set to 1 Hz.



In SSB mode, **APF-AN** turns on *auto-notch* (AN). Auto-notch can suppress one or more audible carriers (continuous tones) automatically, while having little impact on speech signals.

CW/DATA Tuning Aid (CWT)

Accurate tuning of received signals is required before you call a station, or when you’re using built-in text decode (**TEXT**, pg. 21). Signals can always be tuned in by ear, but the KX2 also provides a visual tuning aid (CWT). With CWT on (**MENU:CWT**), the upper half of the S-meter changes as shown below.

CW and PSK31/PSK63

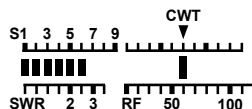

RTTY

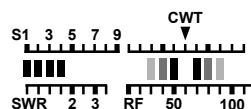

A CW signal appears as a single bar. Tune the signal until the bar is centered beneath “CWT” as shown. This single-bar display also applies to PSK-D (pg. 28).

In RTTY or *radioteletype* modes, mark and space tones appear as bars on either side of the CWT pointer (see FSK D and AFSK A data modes, pg. 28). With no signal, you’ll see a “ghosting” effect (above). As you tune in a signal, solid bars will appear on both sides.

To optimize CW/data text decode, you may need to fine-tune the VFO position. This is especially true in PSK-D mode. Use 1 Hz steps (**RATE**).

Spot and Auto-Spot: Tapping \odot **KYR-SPT/MIC** generates an audible spot tone in CW, PSK-D, and FSK-D modes. Tune the VFO until the signal pitch matches the spot tone. If CWT (see above) is turned on in CW and PSK-D modes, tapping this knob will tune in the signal automatically, if possible (*auto-spot*).

Transmit Settings

The **Transmit** controls group (to the left of the VFO A knob) is used to set up the KX2's transmitter. The nearby **TX LED** turns on during transmit.

⚠ This section provides an overview of transmit controls. Detailed per-mode instructions follow.

Keyer Speed-Spot/Mic Gain and Power Output

In CW mode, \odot **KYR-SPT/MIC** sets the keyer speed (in WPM). Tapping the knob *spots* a signal (pg. 21). In SSB mode, this knob sets mic gain. A typical setting is 15-25 for use with the Elecraft MH3 microphone.

Holding this knob for ~0.5 seconds selects \odot **PWR** (power output control). Power level is shown on the **RF** bar graph during transmit. Maximum power output is typically 10 W on 80-17 m, and 8 W+ on 15-10 m. A power supply voltage of 12 V or higher is recommended for SSB use at full power.

If a KXPA100 amplifier is connected, power can be set up to 100 W (see KXPA100 owner's manual).

⚠ The right side of the KX2 may become quite warm during transmit. If the amplifier temperature is too high, power will be automatically reduced.

⚠ Maximum power output varies with supply voltage and other factors. If output is lower than expected, use the special VFO B displays (pg. 23) to check supply voltage, current drain, and PA temperature. The selected parameter will be shown on VFO B during **TUNE**. (SWR is shown on VFO A.)

Transmit Controls and ATU Tuning

Tap \odot **AF/MON** to set the transmit monitor volume (speech in voice modes, sidetone in CW mode).

XMIT switches the KX2 from receive to transmit. However, in CW/PSK-D/FSK-D modes, **VOX** (*MENU:VOX MD*) is usually set to ON, so you can simply hit the key or keyer paddle to transmit. In SSB mode, tapping **XMIT** is an alternative to using mic PTT or VOX. (See pg. 20 for SSB VOX setup.)

TUNE is used to transmit a CW signal at the power level selected by the \odot **PWR** control. This is useful with external wattmeters and antenna tuners. The *TUN PWR* menu entry can be used to override the PWR control setting and transmit at a lower level.

ATU starts automatic antenna matching if a KXAT2 internal ATU is installed (pg. 19), or if a KXPA100 amp with KXAT100 ATU is connected (pg. 32).

The *ATU MD* menu entry must be set to **AUTO** mode. Matching takes an average of 4 seconds, initially. Settings are then recalled instantly on band change, as well as when you transmit after moving the VFO a significant distance. The ATU icon flashes briefly when L-C network settings are recalled. In CW mode, recall is delayed until a pause in keying (0.5 seconds).

i With difficult loads, try tapping **ATU** a second time within 5 seconds to search for a lower SWR.

PFn (programmable function switch): See pg. 25.

MSG and **REC** are used to play and record CW, data, or digital voice messages (pgs. 22 and 30).

SSB Mode

Use the steps below to do initial SSB setup:

- Set \odot **PWR** to 0.0 W.
- Tap **MODE** to select SSB (either **LSB** or **USB**). To change SSB modes, use *MENU:ALT MD*.
- Tap \odot **AF/MON** to set the voice monitor level. Start with 3. **High settings may sound distorted.**
- Set *MENU:TX CMP* (speech compression) to **0** initially. Exit the menu.
- Tap **XMIT** or hold in the mic's PTT switch. **Note:** Hand-held mics like the Elecraft MH3 should nearly touch your mouth when you are speaking.
- While speaking into the mic, adjust mic gain (\odot **MIC**). This will turn on the transmit **CMP** and **ALC** bar graphs. While speaking, adjust mic gain for about 5 ALC bars (see below). **Mic gain for the Elecraft MH3 is typically set to 15-25, and 30-40 for the internal mic.**

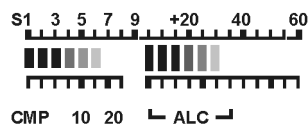

- To use speech compression, set *MENU:TX CMP* to 10-20 initially. Compression increases average “talk power” with only slightly decreased fidelity.
- Exit transmit mode. Set \odot **PWR** to the desired level. **Do not use MIC gain to set power level.** Set mic gain to a fixed level as described above.

VOX Setup

Several menu entries are used to configure SSB VOX (voice-operated transmit):

If *MENU:VOX MD* is OFF (PTT, or push-to-talk mode), the transmitter must be enabled by tapping **XMIT** or by holding the mic's PTT button. With VOX on, the **VOX** icon turns on, and transmit starts by speaking. If VOX is on, the remaining menu entries below should also be set up.

i **VOX cannot be used with the built-in microphone. Use the **XMIT** switch to transmit.**

MENU:VOX GN (VOX gain) should be set to trigger at normal speech level, but not in response to incidental noise. Start with low settings (10-20).

MENU:VOX DLY sets the VOX (voice-operated transmit) delay time in seconds. A setting of about 0.5 seconds will keep the radio in transmit mode during typical continuous speech.

MENU:VOX INH (VOX inhibit, or *anti-vox*) can prevent speaker audio from triggering VOX.

Transmit Metering

In SSB mode, tapping \odot **MIC** switches the transmit bar graph from **SWR / RF** to **CMP / ALC**.

The **CMP / ALC** scale is selected automatically when you adjust mic gain or speech compression. The **SWR / RF** scale is restored after a few seconds.

CW Mode

Basic CW-Mode Setup

- Tap **MODE** to select **CW** (normal CW mode). Some operators prefer to use CW reverse (**CW REV**). See *MENU:ALT MD* for details.
- *MENU:VOX MD* can be set to ON (VOX) or OFF (PTT) for CW mode. Most operators use VOX, allowing the transmitter to be keyed immediately whenever a hand key or keyer paddle is used. PTT requires manual transmit start/stop using **XMIT**.
- Set sidetone pitch using *MENU:PITCH*. 500-700 Hz is typically used with headphones.
- Set sidetone volume using **MON**.
- *MENU:VOX DLY* sets the break-in or *QSK* delay (the time before the receiver recovers after key-up). A setting of 0.00 provides full break-in, also known as “full QSK.” (The QSK icon will appear.) *MENU:CW WGHT* provides two variations on QSK; CW operators may wish to try both.

CW Receive Filtering

As conditions change, you can adjust the filter passband using **FIL** as described on pg. 17. A narrow passband can improve copy in the presence of noise or interference, while a wider passband can be less fatiguing to listen to. You’ll also find the audio peaking filter (**APF**, pg. 18) to be very useful with weak CW signals.

Off-Air Code Practice

Sending CW normally produces both a sidetone and a transmitted signal. If PTT-CW is selected (by setting *MENU:VOX MD* to **OFF**), hitting the key without first tapping **XMIT** will generate only a sidetone. This is useful for code practice or keyer speed adjustment.

CW-Mode Menu Settings

You can use the menu to change the settings for iambic keying (*CW IAMB*), keying weight (*CW WGHT*), and paddle normal/reverse or hand key (*CW KEY1* for the **KEY** jack, and *CW KEY2* for an attached KXPD2 or KXPD3 keyer paddle).

CWT, SPOT and Auto-Spot

When calling a station, you should try to match your frequency to theirs. To facilitate this, the KX2 provides both a visual tuning aid (CWT), as well as manual and automatic spotting in CW and some data modes. See pg. 18.

CW Text Decode/Display

The KX2 can decode transmitted and received CW signals, displaying the text on VFO B (pg. 29). This is especially useful when you’re learning CW, or if someone who doesn’t know CW is looking over your shoulder while you make CW QSOs. It’s also indispensable for CW-to-DATA operation (pg. 27).

CW/DATA Message Record/Play

There are 3 text messages, each having up to 250 characters. These apply to CW as well as DATA modes FSK D and PSK D.

! Messages can only be recorded using the KX2's built-in keyer function (using either an external keyer paddle, KXPD2, or KXPD3). An external keyer cannot be used. Messages can also be viewed or edited using the *KX2 Utility* computer application.

Message Record: To start recording, hold **REC**, then select a message by tapping any of switches **1** through **3** of the numeric keypad (the **PRE**, **FIL**, and **ATU** switches, respectively). The remaining text space will be displayed as you send. Tap **MSG** to finish recording.

Message Play: To play, tap **MSG**, then select a message (**1** through **3**). To cancel, tap **XMIT** or hit the keyer paddle or hand key.

Message Erase: Hold **REC**, select a message (**1** through **3**), then hold **CLR**.

Auto-Repeat: To auto-repeat a message, tap **MSG**, but then *hold* rather than *tap* a message switch (**1** through **3**). *MENU:MSG RPT* sets the message repeat interval (1 to 255 seconds). To cancel auto-repeat, tap **XMIT** or hit the keyer paddle or hand key.

Chaining: *Tapping* a message switch during playback chains another message onto the message being played. *Holding* a message switch during playback chains a repeating message.

Advanced Operating Features

Special VFO B Displays

The KX2 can display time of day and other parameters on the VFO B display. To access these displays, tap **DISP**, then rotate the **⊖ OFS/B** control.

The following special displays are available:

- **24-hour time**, obtained from the real-time-clock on the KXIO2 option module. If a KXIO2 is not installed, the time since last power-on will be displayed. Set the time using *MENU:TIME*.
- **Power supply voltage**. If you have both an internal battery and an external power source connected to the KX2, the display will show the higher of the two voltages. This display, as well as the next two, stay visible even when using **TUNE**, so you can check key-down conditions.
- **Supply current**. Typical receive-mode current is 0.15-0.20 A. It can be reduced by turning off the LCD backlight and preamp, and by using headphones. Transmit current is typically 1 to 3 A.
- **Power Amplifier (PA) temperature**. The KX2's internal PA temperature is shown as **PA.I nnC** (Internal). If a KXPA100 is connected via the remote-control cable, *MENU:PA MODE* is **ON**, and **⊖ PWR** is set to > 10 W, the KXPA100's PA temperature is shown, as **PA.X nnC** (eXternal). PA temperatures rise gradually as you transmit.
- **Audio Signal level (AFV)**. Shows the KX2's audio output level, *prior to* the AF gain control (the AF gain control has no effect on this reading). The reading will vary with preamp and attenuator settings. AFV is used along with **dBV** (below).
- **Relative audio signal (dBV)**. Used to measure receiver sensitivity or gain/loss of various stages, or to compare two signals. To use it, first select **AFV** (described above) and allow the voltage reading to stabilize. (This may not be possible with modulated or rapidly changing signals.) Once the signal appears stable, select **dBV**. You should now see a reading of around 0 *dBV* (see **Glossary**) relative to the last **AFV** reading. If you change the setting of the preamp or attenuator, you should see this reading change. However, it may not change as much as you expect unless you also turn AGC off using the *AGC* menu entry. **(Be sure to turn AF gain down before turning AGC off, as the signal may become very loud.)**
- **Amp hours**: Shows total amp hours used since the value was last reset (for details, see *MENU:AMP HRS*). Used to test batteries or estimate remaining battery charge.
 - **i** Holding **CLR** in the *AMP HRS* menu entry zeros the amp hours value.

Frequency Memories

The KX2 has 100 general-purpose frequency memories (00-99), plus four *quick memories* on each band. Each memory stores VFOs, modes, and other settings. Quick memories provide an easy way to get to segments used for each operating mode. For example, you could use quick-memory **1** as an SSB starting point, use **2** for CW, **3** for data, etc. Memories can be set up manually or with the *Elecraft Frequency Memory Editor* (pg. 34).

To store a general-purpose memory (00-99): First hold **STORE**, then locate the desired memory by rotating the VFO A knob. The VFO A frequencies presently stored in each memory will be shown. When you reach the desired memory number, hold **STORE** again to exit, or tap any other switch to cancel.

To recall a general-purpose memory: Hold **RCL/SCN**, then select a memory using VFO A. Tap any switch to exit.

To store a per-band quick memory: Hold **STORE**, then tap the target quick memory (**1 - 4**).

To recall a per-band quick memory: Hold **RCL/SCN**, then tap the target quick memory (**1 - 4**).

To erase a general-purpose memory: While scrolling through memories to store or recall, hold **CLR**.

To add a text label to a general-purpose memory: First hold **RCL/SCN**, then select a memory (00-99) using VFO A. Next, rotate VFO B to select each text label position in turn as indicated by the flashing cursor. Use VFO A to select label characters (A-Z, 0-9, and symbols). Hold **STORE** to exit.

Scanning

Scanning tunes a band segment continuously until a modulated signal is found. To use scanning:

- Set VFO A and B to the desired scan start/end frequencies, and VFO A to the desired mode. **STORE** in memory 00-99 as described at left.
- To start scanning, first recall a general-purpose frequency memory as described at left. Then hold **RCL/SCN** until **SCAN** appears on VFO B (~3 s).
- To stop scanning, rotate VFO A or tap any switch. To restart, hold **RCL/SCN** for about 3 seconds.

Channel Hopping

Scanning (or manually tuning) among a group of memories is referred to as **channel hopping**. This is especially useful on 60 m. Memories in a group must all be in the same band, but can have different modes.

To set up channel hopping:

- Set up VFO A for the first target frequency and mode. **STORE** this setup in a memory (00-99).
- Set up and **STORE** the remaining frequencies *in the next successive numbered memories*.
- Add a text label to each memory in the group, using an asterisk (*) as the first character.
- To start manual channel hopping, recall one of the memories in the target group. VFO A will now hop among the grouped memories. Holding **RCL/SCN** for ~3 seconds starts scanning within the group.
- To disable channel hopping, tap **RATE**.

Audio Effects

Stereo headphones or dual external speakers can be used with the KX2's DSP *audio effects* (AFX). At present the KX2 provides one audio effects mode, **DELAY**, which creates an illusion of acoustic “space,” resulting in a less-fatiguing sound and in some cases better copy of weak signals. *MENU:AFX MD* is used to select the desired AFX setting.

Dual Watch

Dual watch allows you to listen on both the VFO A and VFO B frequencies, as if you had two receivers. You'll hear the signal at VFO A in the left channel, and the signal at VFO B on the right.

i Stereo headphones or dual external speakers are required to use dual watch.

Dual watch has various uses. For example, you might be waiting for a station on VFO B's frequency to complete a QSO, while using VFO A to look for other stations. You can tap **A / B** to alternate between the two frequencies.

Dual watch is also ideal for working DX stations that are listening at an offset from their transmit frequency. You can listen to the DX station on VFO B, while using VFO A to find the station they're presently working. Once that station has been found, you may want to move up or down slightly to find a clear spot in which to call.

To turn on dual watch: Set *MENU:DUAL RX* to **AUTO**. This turns on the **SUB** (“sub receiver”) icon. If you turn dual watch on/off frequently, you may wish to assign it to **PFn** (described below).

Dual Watch Limitations:

- VFO B can be up to 7 kHz above VFO A, or up to 23 kHz below VFO A. If you exceed this separation with *DUAL RX* turned on, the **SUB** icon flashes slowly as a reminder. This doesn't prevent you from exceeding the separation, but it does disable dual watch until the VFOs are back in range.
- Dual watch overrides the normal audio effects mode (*AFX MD*).
- Headphones or external speakers must be used.

Programmable Function Switch (PFn)

You can access an often-used menu entry quickly by assigning it to the programmable function switch, **PFn**.

To set up the programmable function switch:

- Hold **MENU**, then rotate VFO B to find the target menu entry.
- Hold **PFn** to assign it to this menu entry. You'll see **PFn SET**.
- Exit the menu.

i If a parameter has only two values, accessing it with **PFn** will change the value and exit the menu.

Receive Audio Equalization (RX EQ)

The KX2 provides 8 bands of receive audio equalization via the *RX EQ* menu entry. RX EQ can compensate for physical acoustics (of the room, headphones, internal speaker, external speaker), tailoring the audio to your personal preference.

Two receive EQ setups are provided: one for CW mode, and the other for SSB mode. RX EQ does not apply to DATA modes.

In the *RX EQ* menu entry, the VFO A display shows 8 individual vertical bar graphs. The example below shows various amounts of EQ for each band.

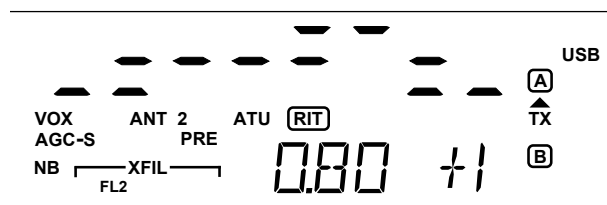

The center frequencies of the 8 audio EQ bands are 50, 100, 200, 400, 800, 1600, 2400, and 3200 Hz. To select a band to change, tap **[0-7]** on the keypad. For example, tapping **0** selects the 50-Hz band.

Next, rotate VFO A to specify boost or cut (+/- 16 dB). The illustration above shows the 800 Hz EQ band (**0.80 kHz**) being set to +1 dB of boost. You can hold **CLR** to reset all of the *RX EQ* bands to 0 dB (no cut or boost).

Transmit Audio Equalization (TX EQ)

⚠ Most microphones, including the Elecraft MH3 and the KX2's built-in mic, will provide good audio quality with default (flat) TX EQ. Also, excessively high TX EQ settings can cause distortion.

If required, transmit audio equalization can compensate for microphone and voice variations. *MENU:TX EQ* works exactly the same as *RX EQ* (described at left) and can be adjusted during transmit. TX EQ is not applicable to CW or DATA modes.

While adjusting *TX EQ*, monitor your voice using headphones (use **MON** to set the level), or listen to your transmitted signal on another receiver. If you hear distortion, reset all TX EQ bands using **CLR**. You may also have excessive mic gain or compression.

SSB/CW VFO Offset

The KX2 can automatically offset the VFO frequency when you switch from SSB to CW mode, so other stations will hear the correct CW pitch. See *MENU:CW WGHT* for details.

Data Modes

The KX2 supports data operation via a computer and special software. But it can also be used in **RTTY** and **PSK31/PSK63** modes *without* a computer, thanks to the built-in FSK D and PSK D modes.

⚠ 5.0 watts or lower is recommended in all data modes. The KX2 will reduce power, if necessary, to maintain a safe operating temperature.

⚠ Mic gain, RX/TX EQ, and TX CMP are not applicable to FSK D and PSK D modes.

FSK D Mode (RTTY)

FSK D (RTTY¹) is the easiest data mode to use:

- Tap **DATA** to select data modes.
- Tap **DATA** again and rotate **⌚** **OFS/B** to select the **FSK D** sub-mode. Tap the switch again to exit the sub-mode display. A dual-passband (mark/space) filter will appear:



- Hold **TEXT** to turn on text decode.
- The sideband can be reversed (*MENU:ALT MD*).
- Optionally turn on the tuning aid (*CWT*, pg. 21).

¹ FSK stands for *frequency-shift keying*, used with RTTY (radioteletype). The KX2 uses a 170 Hz shift. RTTY signals are encoded using a 5-level code called *baudot*, at a baud rate of 45 baud, or about 60 words per minute.

You'll now be able to copy RTTY signals. If you see only numbers and punctuation, try tapping **DATA** twice to restore “letters” mode.

RTTY stations can most often be found on 20 m, from 14080-14090 kHz. Other popular “watering holes” include 80 m (3570-3600), 40 m (~7040 and ~7080), 17 m (~18100), and 15 m (~21080). During contests, stations spread out over a much wider range.

To transmit in FSK D mode (**CW-to-Data**): Plug a keyer paddle into the KEY jack, or attach a KXPD2 (or KXPD3) paddle at the front of the KX2. (See the *CW KEY1* and *CW KEY2* menu entries.) When you send CW, the KX2 will convert it to RTTY. (You'll hear the CW sidetone as well as weak RTTY tones.)

You can use CW message memories in FSK D mode, as well as with *KX2 Utility*'s **Terminal** function (pg. 34).

- i** You cannot use a hand key for FSK D transmit.
- i** The KX2 adds a 4-second “idle time” (giving you time to decide what to say next) each time you stop sending. At the end of this period, the receiver is re-enabled. **To terminate the idle period quickly**, send the character **. . . - -** in CW. This “IM” *prosign* can also be inserted at the end of a message. It will not be transmitted on the air, but you'll hear it in your CW sidetone.

PSK D Mode (PSK31/PSK63)

PSK D is the KX2's built-in version of PSK31 (or PSK63)², a narrow-band data mode which can be reliable even at very low power levels.

To use PSK D mode:

- Tap **DATA** to select data modes.
- Tap **DATA** again and rotate \odot **OFS/B** to select the **PSK D** sub-mode. Use VFO A to select 31 or 63 baud. Tap **DATA** again to exit. A narrow receive passband will be selected.
- Hold **TEXT** to turn on text decode.
- The sideband can be reversed (*MENU:ALT MD*).
- Optionally turn on the tuning aid (*CWT*, pg. 21).

Before attempting to transmit in this mode, you should practice tuning in signals. Try listening to 14070-14073 kHz (20 m), tuning signals in 1 Hz steps until the decode appears accurate.

i A PSK signal can sometimes be tuned in at multiple VFO frequencies, separated by ~8-16 Hz. To ensure you're listening on the correct frequency before you transmit, use auto-spot (pg. 21).

For PSK D transmit, a keyer paddle directly connected to the KX2 is required. Use the "IM" prosign to terminate transmit quickly. (See previous page.)

² PSK stands for *phase-shift keying*. 31 and 63 refer to the baud rates, 31.25 or 62.5 baud. PSK signals are encoded using a very efficient representation called *varicode*.

Audio Data Modes (DATA A and AFSK A)

A computer, sound card, and appropriate software can be used with the KX2 for data communications. Many different modes can be used in this way, including PSK31/63, RTTY, JT65, Pactor, Olivia, MFSK, SSTV, etc. The KX2 provides **DATA A** mode for this purpose. **DATA A** automatically disables compression and RX/TX EQ. Upper sideband is the default.

For audio-based RTTY, you can also use **AFSK A** mode. Like FSK D, **AFSK A** provides a dual-passband RTTY filter and text decode. The VFO is tuned to the mark frequency. Lower sideband is the default.

To use audio data modes:

- Tap **DATA** twice; rotate \odot **OFS/B** to select **DATA A** or **AFSK A**. Tap **DATA** to exit.
- In **AFSK A** mode, optionally hold **TEXT** to turn on text decode. Also see *CWT* (pg. 21).
- Connect your computer's line-audio output to the MIC jack. Connect the KX2's PHONES jack to your computer's line-audio input. Shielded cables should be used. You may need an attenuator if the drive levels are too high.
- Refer to your data communications software manual to determine how to set up the KX2's VFO for accurate frequency display.
- VOX can be used for data; see *MENU:VOX MD*.
- While transmitting audio data, adjust MIC gain for no more than 4 to 5 bars of ALC indication.
- **RX/TX EQ and TX CMP are not applicable to DATA A and AFSK A modes.**

Text Decode And Display

The KX2 can decode CW, PSK31 or PSK63 (PSK D) and RTTY (FSK D). CW speeds from about 8 to 70 WPM can be decoded. Decoded text is displayed on VFO B. If no signal is tuned in, random characters may be displayed.

To set up text decode:

- Select the desired mode (CW, FSK D, or PSK D) using **MODE** or **DATA**.
- If a special VFO B display mode is in effect, cancel it by tapping **DISP**.
- You'll probably want to turn on CWT as a tuning aid (pg. 21). Also, auto-spot (pg. 21) can be used to automatically tune in signals.
- Hold **TEXT**. In DATA modes, this will alternate between **DEC ON** and **DEC OFF**. (The **T** mode icon appears when it is on). In CW mode, use **⌚ OFS/B** to select a text decode mode. **TX ONLY** displays only CW characters you send using the internal keyer. To decode text from on-air CW signals, use one of the **RX THRn** settings. Turn CWT on and adjust the threshold so that the CWT bar graph segment flashes in time with the incoming CW. Use higher **RX THRn** settings for stronger signals as well as faster CW speeds.
- Use a filter bandwidth of **0.30** kHz or less.
- For further details on data modes, see pg. 27.

Split Operation

Often you'll hear a DX station being called by many stations, creating a *pileup*. To ensure that he has a clear transmit channel, the DX station may say "UP" or "DOWN" periodically to indicate that he's *listening* above or below his transmit frequency. For example, in CW mode he might transmit on 14025 kHz, but listen in the vicinity of 14027 kHz. In this case he would periodically send "UP 2" (or just "UP") as a reminder of where to call him. SSB pileup-split operation is similar but may occur over a much wider range.

To use split, first hold **A > B** twice to set VFO B to the same mode, frequency, and filter settings as VFO A. Then tune VFO B up about 2 kHz (or the desired offset). Finally, hold **SPLIT**. The **SPLIT** icon will turn on, and the **TX** icon will point at VFO B, since VFO B is now controlling your transmit frequency.

Using dual watch with and without SPLIT

DX stations will tune in the vicinity of their specified listening frequency when searching for callers. Finding a clear spot in which to transmit will improve your chance of being heard. This is where dual watch comes in. With dual watch ON, you can listen to your RX and TX frequencies at the same time (pg. 25). You'll be able to tune VFO B to find a clear spot, while still listening to the DX station at VFO A's frequency. VFO B can be set up to 7 kHz above or 23 kHz below VFO A. Outside this range, dual watch is disabled, and the **SUB** icon flashes as a reminder.

If an SSB-mode pileup extends more than 7 kHz *above* the DX station, you can use a different technique that

allows you to transmit as much as to 23 kHz up. To do this, simply turn split OFF (VFO A will then be the TX VFO), and listen to the DX station with VFO B (using dual watch). This is actually easier than normal split operation, because VFO A has a larger tuning knob.

Digital Voice Recorder (DVR)

You can record two SSB-mode transmit voice messages of up to 15 s each, such as your call sign or a CQ, and play them back one time or with auto-repeat. This can save your voice, especially in an SSB contest. For example, you could record your callsign in one message and a fixed exchange in the other.

⚠ The transmit voice monitor should be used so you can hear DVR playback. This can be adjusted in receive mode. First, tap  **AF/MON** to select the monitor level function. Then, while speaking into the mic, use this knob to adjust the level. Start with 5.

DVR Record:

Hold **REC**, then tap **1** or **2** on the numeric keypad. The current message will be erased (4 s). When prompted, tap **XMIT** and start speaking into the mic (no need to push PTT). Tap **XMIT** again to terminate record. MIC gain cannot be adjusted during DVR message play. The gain setting at time of recording is used.

DVR Play:

Tap **MSG**, then tap **1** or **2**. To cancel, tap **XMIT** or hit the key. To auto-repeat a message, tap **MSG**, but then *hold* rather than *tap* **1** or **2**. *MENU:MSG RPT* sets the repeat interval (1 to 255 seconds).

Transmit Noise Gate

The noise gate function mutes mic audio below a selected audio threshold. This is useful in vehicles and when operating in noisy outdoor environments. See *MENU:TX GATE* for details.

Cross-Mode Operation

Cross-mode operation is possible in some cases. For example, you could set up VFO A for SSB receive, and VFO B for CW transmit, then enter **SPLIT**. When you transmit, the SSB station will hear your CW signal at the pitch of your sideone. Use a fairly slow CW speed, e.g. 15 WPM, if you're not sure of the SSB operator's code proficiency level.

i You can also send CW in SSB mode without using split, if the CW-in-SSB feature is enabled. See *MENU:CW WGHT* for details.

Custom Power-On Banner

Your KX2 can display a customized text “banner” on power-up, such as your name and callsign. The banner scrolls across the VFO B display.

To set up a banner, use the Configuration screen of the *KX2 Utility* application.

Transverter Bands

Seven user-definable band displays are provided for use with external transverters, such as the Elecraft XV-Series.

⚠ The KX2 does not have a low-level transverter output; transverters are driven from the main antenna jack. This requires the use of transverters that have a common receive/transmit antenna jack and associated T/R switching. Consult the transverter manual for drive power limitations and switching requirements.

The KX2's ACC jack provides a keyline output that can be used to key transverters. See pg. 9.

Transverter Band Setup

Transverter bands are set up using the five *XV* menu entries, as follows:

- Locate the *XVn ON* menu entry. Tap **1**–**7** to specify which transverter band to configure. Set the parameter to **YES** to enable band *n*.
- *XVn RF* sets the operating frequency (MHz).
- *XVn IF* specifies the I.F. band (7, 14, 21, 28, or 50 MHz). Most transverters use a 28 MHz I.F.
- *XVn PWR* sets maximum KX2 power output for the current transverter band in watts.
- *XVn OFS* can compensate for a frequency offset in the transverter.

Options and Accessories

This section describes all available KX2 options and accessories. Option modules are easily user-installable, in any order, without soldering.

MH3 hand mic: The MH3 microphone includes a high-quality element, space-saving right-angle plug, PTT switch, and VFO UP/DN function buttons.

KXPD2 keyer paddle: The KXPD2 is a very compact mechanical keyer paddle that attaches directly to the front of KX2 (or KX3). This eliminates the need for a heavy keyer base. It includes a slot in which to store the contact-adjustment allen wrench.

⚠ A KXPD3 keyer paddle can also be used with the KX2, though a modification may be required. Until very recently, the KXPD3 was shipped with one long thumb screw and one short. The longer thumb screw must be replaced with another short one for use with the KX2, because the longer screw will project too far into the KX2's enclosure. (The KXPD3 will still work normally with the KX3 after modification.) Contact Elecraft for KXPD3 modification instructions.

KXIO2 real-time clock module with 2 general-purpose outputs: The KXIO2 option provides a real-time clock and two user-programmable outputs (AUX jack). The time can be displayed in the KX2's VFO B area (see pg. 23 and the *TIME* menu entry). The two AUX outputs can be used for controlling external equipment such as an antenna switch (see the *AUX 1* and *AUX 2* menu entries).

KXAT2 wide-range internal automatic antenna tuner (ATU): With a KXAT2 installed, you can use non-resonant and narrow-band antennas. An ATU can improve transmit power output and receive sensitivity.

KXPA100 100-watt amplifier: The KXPA100 is a rugged 100 W, 160-6 m linear amplifier that can be used with the KX2, KX3, or any other QRP transceivers. An internal 100 W ATU is also available for the amplifier (KXAT100). The KX2 can remotely tune the 100 W ATU (pg. 19) and control its antenna switch (*MENU:ANT.X SW*). If a KXAT100 is available, the the KX2's internal ATU (KXAT2) will be placed into bypass mode automatically.

⚠ A KX2 Accessory Cable (KX2ACBL) is required to split the KX2's ACC jack into two jacks: KEY OUT (2.5 mm) and serial I/O (3.5 mm). The KXPA100 comes with cables that plug into these two jacks.

CS40 and CS60 carrying cases: These are high-quality, padded carrying cases with an internal zippered compartment. The **CS40** is extremely compact, but still provides space for the KX2, antenna wire, an earbud-style headset (with 1/8th-inch plugs for both earbuds and mic), a few adapters, and a small operating log. The larger **CS60** has space for an MH3 microphone and additional items.

KX2GNDPLUG: This mini-banana plug can be used to make a quick-disconnect ground wire (pg. 10).

BNC-BP: BNC to binding-post adapter for secure attachment of wire antennas to the KX2 (pg. 10).

Firmware Upgrades

New features and improvements are available to all KX2 owners via free firmware upgrades. Upgrades may also be required when you install option modules.

Please visit the Elecraft KX2 software page (www.elecraft.com/KX2/KX2_software.htm) to obtain our free firmware download application, *KX2 Utility*. This program runs on PCs, Macs, and Linux platforms. In addition to firmware downloading, *KX2 Utility* provides automated TX gain calibration, a custom power-on banner, configuration save/restore, CW/DATA message editing, and a CW/DATA terminal function.

Connecting the KX2 to a Computer

The KX2 is supplied with cable for connection to a computer. The standard cable is model KXUSB, for use with a USB port. Cable model KXSER is available for use with an RS232 port.

At the KX2 end, connect this cable to the 3.5 mm ACC jack. (ACC cable pinout is shown on pg. 9 for reference.)

Within *KX2 Utility*, select the new USB or RS232 **com** port associated with the KX2's serial cable.

 Some applications or peripheral devices may interfere with KX2 downloads; check the Help information in *KX2 Utility* if you have difficulty.

Checking your Firmware Revision

Use the *FW REVS* menu entry to determine your firmware revision. The serial number of your transceiver, if needed, can be obtained using the *SER NUM* menu entry.

KX2 Firmware Self-Test

If the KX2 detects an error in its firmware (an incorrect *checksum* of all bytes in the program), it will flash the **TX LED** and show **MCU LD** on the LCD.

If this occurs, connect the KX2 to your computer, then run *KX2 Utility*, which will reload the firmware. While firmware is loading, the Delta-F LED (Δf) will flash. When the download is complete, the KX2 should reset and run normally.

Forcing a Firmware Download

If you accidentally load an old or incompatible firmware version and find the KX2 unresponsive, do the following: (1) Unplug the KX2 from the power supply. If an internal battery pack is installed, disconnect and remove it. (2) Plug a power supply in (or reinstall the removed battery). (3) hold the KX2's **RATE** and **A/B** switches simultaneously for about 10 seconds, after which you'll see the **TX LED** flash (you'll also see **MCU LD** on the LCD). (4) Connect the KX2 to a computer and run *KX2 Utility*, which will load new firmware.

Remote Control of the KX2

Computer Control and Logging

With appropriate software, any computer with an RS232 or USB port can be used to control the KX2. See **Connecting the KX2 to a Computer** (pg. 33).

Third-party logging and contesting software is available for various computers and operating systems. Select KX2 as the target radio when available. If not, select another Elecraft transceiver.

For a list of compatible software applications, including configuration requirements, please visit

http://www.elecraft.com/k2_remote.htm

Remote-Control Commands

The KX2 has a rich set of remote-control commands. These commands use ordinary ASCII characters, so they can be easily tested using a terminal emulator or the Command Tester screen in *KX2 Utility*. For example, the command “**FA;**” returns the current VFO A frequency. Using the same command, you can *set* the frequency, e.g. “FA00007040000;” sets the VFO to 7.040 MHz.

Many specialized commands are provided in addition to the core set of commands supported by the K3S/K3. Please refer to the ***K3S/K3/KX3/KX2 Programmer’s Reference*** for further details.

Automatic Antenna Control

Some antenna control units (e.g., those used with SteppIR™ antennas) can track the KX2’s band and frequency by watching for “**IF;**” (rig information) packets from the transceiver’s serial port (ACC jack). To configure the KX2 to send these packets, set **MENU:AUTOINF** to **ANT CTRL**. The packets are sent once per second while the VFO frequency is being changed, as well as on band or mode change.

CW/DATA Terminal Applications

The KX2 can handle CW/PSK/RTTY ASCII text transmit and receive via its ACC port (RS232 or USB). Our ***KX2 Utility*** application includes a *Terminal* function that lets you use these modes with your computer’s keyboard and monitor. At the KX2, select FSK-D data submode for RTTY, PSK-D for PSK31 or PSK63, or CW. Then follow the Help instructions within *KX2 Utility*.

Elecraft Frequency Memory Editor

The KX2’s frequency memories (pg. 24) can be easily viewed and changed using our ***Elecraft Frequency Memory Editor***. This program shows the contents of all 100 regular memories, as well as per-band quick-memories, in a spreadsheet format. You can also set VFO A directly to a memory from within the program.

Configuration

Option Module Enables

Whenever an option is installed, use the associated menu entry to set it up (see **Menu Functions**, pg. 40).

When installing internal options, open the KX2 enclosure using the procedure on pg. 6.

- **KXAT2 Antenna Tuner (ATU):** Set *ATU MD* to **AUTO**. Exit the menu and turn the KX2 off, then back on. See pg. 10 for recommended antennas and pg. 19 for ATU controls.
- **KXPD2 (or KXPD3) Keyer Paddle:** Set *CW KEY2* to **LeFT** paddle = **DOT** (normal) or = **DASH** (reverse). If you set it to **HAND**, either paddle can be used as a hand key. (The **KEY** jack on the left side panel is configured using the *CW KEY1* menu entry. The keying device plugged into **KEY** is independent of the KXPD2 or KXPD3.)
- **KXIO2 Extended I/O Option (with RTC):** Set *KXIO2* menu entry to **NOR**. Exit the menu and turn the KX2 off, then back on. Set time using the *TIME* menu entry. See the *AUX 1* and *AUX 2* menu entries to configure the AUX outputs.
- **KXPA100 External 100-W amplifier:** See *PA MODE* menu entry and KXPA100 manual.

⚠ After changing option enables, use *KX2 Utility* to save your configuration. The configuration can then be restored later if later required.

Menu Settings

The menu entries described in this section are often used to tailor the KX2 to the operator's requirements. You may also wish to review the full list of menu entries, starting on pg. 40.

Auto Power-Off

The KX2 can turn itself off after a specified period of inactivity (i.e., no use of the controls). Use the *AUTOOFF* menu entry to select the time period in minutes. The default is **INFINITE**.

Low-Battery Warning

You can set *BAT MIN* to warn you when an internal or external battery is approaching end of charge. **BAT LOW** is displayed periodically when this level is reached. The default voltage (**10.0 V**) is appropriate for many 12 V batteries, as well as the specified internal 11 V battery.

⚠ The KX2 will turn itself off when the supply voltage drops below about 7.5 volts, regardless of the *BAT MIN* setting.

CW Iambic Mode

CW users can specify Iambic mode A or B using the *CW IAMB* menu entry. The default is mode **A**, which is a little more forgiving. Mode **B** may be preferred by operators who do “squeeze” keying. Both modes

provide dot- and dash-memories—enabling fast code speeds—but with slightly different timing.

Microphone Settings



If you plan to use voice modes, set up *MIC BIAS* and *MIC BTN* to match your microphone.

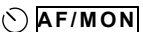

Switch-Press Tones

Switch-press tones are enabled by default. Using the *SW TONE* menu entry, you can turn tones **OFF**, **ON**, or select Morse code tones at various speeds (**CODE nn**). Switch tones use the CW sidetone volume level, which can be adjusted in CW mode using the  **AF/MON** control.

Setting the Time

MENU:TIME sets the 24-hour real-time-clock (RTC) if a KXIO2 module is installed and *MENU:KXIO2* is set to **NOR**. If no KXIO2 is installed, time will start at **00:00:00** at power-up.

While in the menu entry, tap  /  /  to select HH/MM/SS (hours/minutes/seconds), respectively. Then use VFO A to adjust the value. *KX2 Utility* can also be used to accurately set the time.

To display the present time, tap  and rotate  to locate the time display.

If the clock appears to be off by more than +/- 2 seconds per day, use the *RTC ADJ* menu entry to apply a correction.

 The clock circuitry must be powered by either the KX2's internal battery or an external supply. Refer to the *KXIO2* menu entry for details.

VFO Coarse Tuning Steps

VFO CRS can be used to set up a coarse tuning increment for each mode. Tap  to select normal or coarse tuning.

TUNE Power Level

If you're using an external antenna tuner or amplifier with the KX2, you may want to limit the power level used during . The *TUN PWR* menu entry can be used to set the desired power level.

 If you have the KXAT2 internal ATU installed, power is automatically set to 3.0 watts during antenna tuning. There's no need to configure *TUN PWR* in this case.

VOX (Voice Operated Transmit) Setup

If you plan to use VOX in SSB or data modes, you'll need to set up the *VOX GN* and *VOX INH* (anti-VOX) menu entries. See pg. 20.

 **After changing menu settings, use *KX2 Utility* to save your present configuration.** The configuration can be restored later if required.

Calibration

⚠ All calibration steps are performed at the factory. If you wish to re-do any calibration steps, be sure you have the test equipment specified.

To view the *tech-mode* menu entries used for calibration: Hold **MENU**, then use **OFS/B** to locate the *TECH MD* menu entry. Change the parameter to **ON**. Then exit the menu.

To unlock the parameter for any tech-mode menu entry: Hold **FREQ** until you see the lock symbol (🔒) turn off (about 3 seconds).

Reference Frequency

Using the calibration procedure below, you can achieve accuracy of better than +/- 10 Hz. This procedure requires a stable signal generator, or an on-air signal at a known frequency, such as WWV at 5, 10, or 15 MHz. The carrier of a commercial AM broadcast station can also be used.

- Select CW mode by tapping **MODE**.
- Hold **MENU**. Rotate **OFS/B** to find *DUAL RX*. Set it to **OFF**. Next, locate *MENU:CWT* and set it to **ON**. Then exit the menu.
- If you're using a signal generator, set **PWR** to 0.0 watts to avoid damaging it.
- Use direct frequency entry (pg. 15) to set VFO A to the *exact* frequency of your signal generator or on-air signal source.

- Set AF gain for a comfortable listening level. You should be able to hear a carrier.
- Tap **FIL**, then tap **AF/MON** to normalize the filter passband (0.40 kHz). Tap **FIL** again to exit **FIL ADJ** mode.
- Hold **MENU**, then rotate **OFS/B** to locate the *REF CAL* menu entry. Hold **FREQ** for about 3 seconds to unlock the parameter.
- Write down the current 8-digit parameter value:
_____ .
- Tap **KYR-SPT** to *auto-spot* the signal. The *REF CAL* parameter value should automatically move up or down a small amount. When it stops moving, the bar directly beneath the CWT icon should be turned on as shown below. You can also adjust the frequency manually using VFO A.

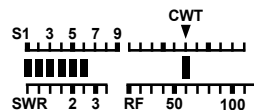

- If you have difficulty with this procedure, or if you're not sure that it worked correctly, set the parameter value to its original value (recorded above) using VFO A.
- Write down the new 8-digit parameter value:
_____ .
- Exit the menu by tapping **DISP**.
- Save your configuration using *KX2 Utility*.

Receive Opposite Sideband

Receive sideband calibration nulls (rejects) the *opposite-sideband image*. This image is a weak audible side-effect of listening to very strong signals.

⚠ This procedure is normally done only at the factory. Instructions available on request.

Transmit Bias

This automated procedure sets the transmit bias current of the 10 W amplifier stage to ensure low distortion.

- Make sure nothing is connected to the KX2's antenna jack.
- Hold **MENU**, then rotate **⌚** **OFS/B** to locate the **TX BIAS** menu entry. Hold **FREQ** for about 3 seconds to unlock the two parameters. **Note:** These parameters cannot be manually adjusted.
- Select CW mode by tapping **MODE**.
- Tap **XMIT** to start CW bias calibration. This may take 3-10 seconds. If an error message appears at the end (**ERR nnn**), see **Troubleshooting**.
- Select SSB mode (LSB or USB) by tapping **MODE**.
- Tap **XMIT** to start SSB bias calibration.
- Exit the menu by tapping **DISP**.
- Save your configuration using *KX2 Utility*.

Transmit Gain

This procedure compensates for per-band transmit gain variations. An 11-14 V power supply or battery is required, as well as a 6-W (or higher) dummy load.

Automated Transmit Gain Calibration

To use automated gain calibration (recommended), connect the KX2 to a computer, run *KX2 Utility*, and select the **Calibration** tab. Click on **Calibrate Transmitter Gain**. Follow the on-screen instructions.

Manual Transmit Gain Calibration

- Use direct frequency entry (pg. 15) to set the KX2's operating frequency to 3.7 MHz (80 m).
- If you have the KXAT2 ATU option installed, put it into bypass mode using *MENU:ATU MD*. Set the **TUN PWR** menu entry to **NOR**. Exit the menu.
- Connect a 6-W dummy load to the BNC jack.
- Set **⌚** **PWR** to exactly **6.0** watts (pg. 19).
- Hold **TUNE**; wait until VFO B shows **6.0** W.
- Tap **XMIT** to exit TUNE.
- **Repeat the above procedure on 60-10 meters.** Use approximately the following frequencies: 5.4 MHz (60 m), 7.1 MHz (40 m), 10.1 MHz (30 m), 14.1 MHz (20 m), 18.1 MHz (17 m), 21.2 MHz (15 m), 24.9 MHz (12 m), and 28.8 MHz (10 m).
- Save your configuration using *KX2 Utility*.

Transmit Carrier

In SSB and some data modes, a transmitter's primary signal may be accompanied by a weak unmodulated signal called a *carrier* about 1 kHz away. The carrier should be suppressed (or nulled) to minimize interference to nearby stations. The *TXCRNUL* menu entry is used for this purpose.

⚠ This procedure requires a spectrum analyzer, and is normally done only at the factory. Instructions available on request.

Transmit Opposite Sideband

In SSB and some data modes, a transmitter's primary signal may be accompanied by a weak *opposite sideband* signal about 2 kHz away. This signal should be suppressed (or nulled) to minimize interference to nearby stations. The *TXSBNUL* menu entry is used for this purpose.

⚠ This procedure requires a spectrum analyzer, and is normally done only at the factory. Instructions available on request.

Menu Functions

Hold **MENU** to enter the KX2's menu. Tap or hold this switch to exit. A menu entry that you'd like quick access to can be assigned to **PFn**, the programmable function switch (pg. 25). **Note: NOR** appears in some parameter displays. This means "Normal," i.e. the default or recommended value.

Menu Help Information

Holding **MENU** for about 3 seconds while in the menu shows information about the present menu entry on VFO B. For most entries, the default parameter value is shown in parentheses at the start of the help text. Tap the switch to terminate the help text display.

Tech-Mode menu entries

The  symbol in the table below indicates a *tech mode* menu entry. These are typically used for calibration. Their parameter values are locked by default, as indicated by the lock symbol on the display. To reveal all tech-mode menu entries, set **MENU:TECH MD** to **ON**. To change any tech-mode parameter, you must first unlock it by holding **FREQ** for about 3 seconds. This turns off the lock symbol.

Entry	Default	Description
2 TONE 	OFF	Enables built-in 2-tone generator for SSB transmit tests. The internal 2-tone generator only works if LSB or USB mode is selected. After setting 2-tone ON , exit the menu and tap XMIT .
AF LIM	NOR 030	Adjustable AF output limiter for use when AGC is turned off (MENU:AGC MD) . This can protect your ears if a large signal appears. Signals or noise above the threshold will sound distorted due to the limiting, reminding you to back down AF gain (or RF gain, if you're using MENU:RF GAIN to control receive gain). Typical settings for those who often turn AGC off are 17 to 23.
AFX MD	Delay	DELAY setting (default) provides quasi-stereo audio, reducing operating fatigue when using stereo headphones or dual external speakers.
AGC MD	ON	Some operators prefer to turn AGC off and control RF gain manually. This can be done with the preamp and attenuator, or using MENU:RF GAIN . (When AGC is off, the AGC icons on the LCD change to AGC- , with the "minus" sign meaning

		<p>“off”. Turning AGC off also disables noise reduction.)</p> <p>If an uncomfortably-strong signal appears in your headphones or speaker with AGC off, reduce the threshold of the AGC-off audio limiter (<i>MENU:AF LIM</i>).</p>
AGC SPD	SLO	This setting is stored per-mode. The default for CW mode is FAST , and for other modes, SLO . The setting is indicated by the AGC S and F display icons.
AGC*THR	007	<p>This menu entry provides access to several AGC parameters, each of which starts with AGC*. For most purposes the defaults will suffice. Tap the 1 through 6 switches to access the following parameters (defaults in parentheses):</p> <p>1 AGC*THR (007): Threshold at which AGC action begins. A higher number moves the threshold up, providing greater audio dynamic range.</p> <p>2 AGC*ATK (215): Rate of AGC attack. A lower number than the default provides a softer attack but may also result in overshoot.</p> <p>3 AGC*HLD (000): Hold time in seconds for voice modes. Prevents AGC decay for a specified time after attack, reducing AGC interaction with signals.</p> <p>4 AGC*DCY (Fast, 140; Slow, 040): Specifies the decay rate for slow or fast AGC (see AGC SPD menu entry). A larger number means a faster decay.</p> <p>5 AGC*SLP (015): The higher the slope number, the "flatter" the AGC response is. With a high setting of slope, signals above the AGC threshold will be held close in audio amplitude even if they vary in strength at the RF input.</p> <p>6 AGC*PLS (NOR): Noise pulse rejection. Prevents the AGC (and S-meter) from charging up on one-shot noise events. Set it to OFF to disable this feature.</p>
ALT MD	NOR	<p>CW mode: If set to NOR, CW <i>normal</i> will be in effect on the present band. Set to ALT to use CW <i>reverse</i> mode instead (REV icon turns on). CW normal uses LSB (lower sideband), while CW reverse uses USB (upper sideband). This selection affects the direction of VFO tuning for increasing pitch as CW signals are tuned in. In some cases switching from one to the other can reduce QRM.</p> <p>SSB mode: If set the NOR, the sideband normally used on the present band will be in effect: LSB on 160, 80, and 40 meters, and USB on 60, 30, 20, 17, 12, and 10 m. Setting ALT MD to ALT will select the other sideband for the present band.</p> <p>DATA modes: DATA A and PSK D normally use USB, while AFSK A and</p>



		FSK D use LSB. ALT selects the other sideband (data <i>reverse</i>) for the current data submode, turning on the REV icon.
AMP HRS	N/A	Shows total amp hours used by the KX2. This is useful for testing battery packs, estimating remaining battery charge, or tracking the amp hours needed to complete one or more objectives (e.g., a certain number of QSOs at a given power level). The value is preserved on power-off, so it can show amp hours used over any number of operating sessions. Holding CLR resets the value to 0.000; this is typically done after swapping in a fresh battery. (Amp hours is also one of the special VFO B displays; tap DISP , then rotate VFO B until you see n.nnnAH . This display persists during transmit so you can monitor the rate of increase. In receive mode, the amp hour value will go up by .001 every 20-25 seconds. In transmit mode, the value will go up by .001 every 2 to 10 seconds, depending on operating mode, power setting, and antenna load impedance (all three can affect current drain).
ANT.X SW	1	This menu entry (eXternal Antenna switch) can be used to remotely select antenna 1 or 2 on the KXPA100. Requirements: (1) a KXPA100 with the KXAT100 ATU option must be connected to the KX2 via the amplifier control cable; (2) the KX2's PA MODE menu entry must be set to ON .
ATU MD ATU.X MD	Not Inst	Normally, this menu entry's name is ATU MD , and it controls the mode of the KX2's internal automatic antenna tuner (KXAT2 option). If a KXPA100 with a KXAT100 ATU option is connected via the remote-control cable, and PA MODE is ON , the menu entry changes to ATU.X MD (.X = eXternal). In this case the menu entry controls the auto-tune mode of the KXAT100. The parameter is normally set to BYP or AUTO . Modes L1-L7 , C1-C7 , and Ct are used to test the KXAT2's relays and L-network (not applicable to the KXAT100). Holding CLR while in this menu entry clears stored LC data for the present band (applies to whichever ATU is in use, KXAT2 or KXAT100).
AUTO INF 	NOR	If set to ANT CTRL , the KX2 will send band data ("automatic info") to its ACC jack for use with devices such as SteppIR™ antennas. The data is sent on every



		band or mode change, and once per second as the VFO is moved. See pg. 34.
AUTO OFF	INFINITE	Sets auto-power-off time in minutes (the timer is retriggered when any control is used, and during transmit). If set to INFINITE , power is never turned off. A setting of 5 or 10 minutes is recommended when running from batteries.
AUX 1 and AUX 2	OFF	Used to set the KXIO2 option module's AUX outputs to ON or OFF on a per-band basis. Details: The AUX jack provides a ground (0 V) and two <i>open-drain</i> output signals: AUX 1 and AUX 2. Open-drain outputs simulate a contact closure to ground when in the ON condition, and are floating (high-impedance) when OFF. Typically, the ON state would be used to turn on a relay connected to a DC supply voltage (28 V max, 150 mA max). The two outputs could be used singly or in combination to switch an external device such as an antenna switch, select taps on a loading coil, etc. This could be especially useful during mobile operation. (Note: Elecraft does not yet offer any products that make use of the AUX outputs, but may in the future.)
BAT MIN	10.0	Low-battery warning threshold. The default (10.0 volts) is sufficient for use with some 12 V batteries such as gel cells, as well as for the specified 11 V Li-ion battery pack. If the internal battery or external supply/battery voltage drops below the selected level, the operator will be alerted with BAT LOW messages every few minutes. Regardless of this setting, the KX2 will turn itself off if the supply voltage drops below 7.5 V. To extend battery life, turn the backlight and preamp off when not needed, and use headphones rather than the internal speaker.
BKLIGHT	ON	LCD backlight on/off. The display is transfective, so it can be seen in sunlight with the backlight turned off. Turning it off will extend battery life.
COR LVL 	NOR 0.1	Sets the carrier-operated-relay (COR) threshold. The COR is used to detect, and protect the KX2's receiver from a transmitter being used nearby. 0.1 watts is the default and recommended level. See Troubleshooting for other suggestions.
CW IAMB	A	Iambic keying mode (A or B). The default is mode A , which is a little more forgiving for first-time operators. Mode B may be preferred by operators who learned to do "squeeze-keying" with another keyer having this or a similar mode.



		Both modes provide dot- and dash-memories—enabling fast code speeds—but with slightly different “element-insert” timing.
CW KEY1	TIP=DOT	Specifies whether the left keyer paddle (<i>tip</i> contact on the KEY jack) is DOT or DASH . A third selection, HAND , allows either tip or ring to function as a hand key, or as an input for an external keying device (keyer, computer, etc.).
CW KEY2	LFT=DOT	Specifies whether the left lever of a KXPD2 (or KXPD3) keyer paddle is DOT or DASH . A third selection, HAND , allows either lever to function as a hand key, or as an input for an external keying device (keyer, computer, etc.).
CWT	OFF	When set to ON , the upper half of the S-meter becomes a tuning aid for CW, PSK31/63 (PSK D mode), or RTTY (FSK-D mode) signals. Also, when CWT is on in CW or PSK D modes, the manual signal spotting function of the KYR-SPT/MIC knob changes to <i>auto-spot</i> (pg. 21). In this case the KX2 will attempt to tune in CW or PSK31/63 signals automatically.
CW WGHT	1.25	Adjusts element/space timing ratio (weight) for the internal keyer. Additional functions of this menu entry, via numeric keypad: Tap 1 to select SSB -CW (default) or SSB +CW (allows CW in SSB modes). When CW-in-SSB is in effect, tapping the KYR-SPT/MIC knob in SSB mode alternates between keyer speed and mic gain rather than CMP/ALC and SWR/RF transmit metering. CW transmit in SSB mode is not available if SPLIT is on. Tap 3 to select NOR QSK (default) or FST QSK . The FST (fast) setting provides somewhat faster receive recovery time, while NOR (normal) is less susceptible to audio artifacts from noise and nearby interfering stations. Tap 4 to select VOX NOR (default) or AUTO OFF . The AUTO OFF setting turns CW VOX <i>off</i> on power-up, avoiding accidental keying by attached PCs, etc. Tap 5 to select automatic VFO offset on any SSB/CW mode change (VFO OFS). VFO NOR , the default, disables the offset. Automatic offset is useful when mixed-mode QSOs are necessary, as during fading. Note: Pitch matching for automatic offset will be more accurate if USB is paired with CW reverse, and LSB with CW normal. See <i>MENU:ALT MD</i> .
DUAL RX	OFF	Set to AUTO to enable <i>Dual Watch</i> (pg. 25). The SUB icon will turn on. If the VFOs are not within the required range, the SUB icon will flash slowly. Note:



		Dual watch only applies when using stereo headphones or dual external speakers.
FW REVS	N/A	Rotate VFO A to see firmware revisions: MCU (μC , shorthand for <i>microcontroller</i>), DSP (dSP), and KXPA100 amplifier MCU if applicable (PA). Tap [1] to see the RF board revision, e.g. “RFPCB=A” for rev. A.
KXIO2	Not inst	If a KXIO2 module is installed, set the parameter to NOR , then exit the menu and turn the KX2 off/on. To set the time, use the <i>TIME</i> menu entry. Use the <i>RTC ADJ</i> menu entry to improve the clock’s long-term accuracy if desired. Note: The real-time clock circuitry must normally be powered by either the KX2’s internal battery or an external power source. As a convenience for recharging the battery, which must be done externally to the KX2, the clock will keep time for up to about 2 hours with no power supply or battery connected. This capability is provided by a supercapacitor on the KXIO2 module (see pg. 7). The KXIO2 also provides two open-drain signals on its AUX jack. These could be used for antenna switching or other applications. See the <i>AUX 1</i> and <i>AUX 2</i> menu entries.
LCDTEST	OFF	Rotate VFO A to turn on all LCD segments for test purposes.
LED BRT	4	In the case where the LCD backlight is turned OFF , this menu entry adjusts brightness of the discrete LEDs (TX, delta-F, OFS, and VFO B LED). Does not set brightness of the LCD backlight itself (for that adjustment, use <i>BKLIGHT</i>).
MIC BIAS	ON	Set to ON for the Elecraft MH3. (Not applicable to the internal mic.) You may need to try both <i>MIC BIAS</i> settings to see which works best with other mics. Monitor your transmitted signal with another receiver when testing mic audio.
MIC BTN	PTT UP.DN	If your mic has both a PTT switch and UP/DN buttons, set the parameter to PTT UP.DN . This applies to the Elecraft MH3. If the mic has PTT but no UP/DN buttons, use PTT . Otherwise, use OFF . This setting applies to most headset-mics, including the Heil models available from Elecraft. Third-party mics may not have a KX2-compatible PTT (push-to-talk) switch. You can still key the transmitter either by tapping the XMIT switch or by using VOX (pg. 20).
MSG RPT	6	Message repeat interval in seconds (0 to 255). To repeat a message, hold a message button ([1]–[3]) rather than <i>tap</i> . A 6 - 10 sec. interval is about right for casual CQing. Shorter intervals may be needed during contests, and longer for





		periodic CW beacons.
PA MODE	OFF	<p>Sets the operating mode for Elecraft KXPA100 amplifier and its internal ATU. Set to ON only if the KX2 is connected to the KXPA100 via the KX2 Accessory Cable (KX2ACBL), which plugs into the ACC jack at the KX2. This allows the KX2 to control the amplifier's output power and ATU tuning as described in the KXPA100 owner's manual. <i>ATU MD</i> becomes <i>ATU.X MD</i> in this case, and the <i>ANT.X SW</i> menu entry can be used to switch antennas at the KXPA100.</p> <p>Set to OFF otherwise.</p> <p>If PA MODE is set to P out CAL, a KXPA100 is connected via the remote-control cable, and PWR is set to CAL 75W, going into TUNE mode will calibrate the KX2's drive level for 75 W output at the KXPA100, on the present band. This overrides the KXPA100's factory aligned, per-band drive-power calibration, and should not be necessary under normal circumstances. Also see <i>MENU:TX GAIN</i>.</p>
PITCH	0.60	<p>Sets the CW sidetone pitch in kHz. This is also the pitch of CW signals when centered in the receiver's passband. Note: In PSK-D mode (PSK31/63), the center pitch is 1000 Hz (fixed). In FSK-D mode (RTTY), the mark tone is 915 Hz (fixed).</p>
REF CAL 	25.000.000 (+/- 1 kHz)	<p>Used to calibrate the KX2's synthesizer; normally done at the factory. VFO A is used to set the reference frequency (typically 24.999-25.001 MHz). Refer to pg. 37 for calibration details.</p>
RF GAIN	NOR -0 dB	<p>Normally, RF GAIN is set to NOR -0 dB (no gain reduction). However, some operators prefer to turn automatic gain control off (using <i>MENU:AGC MD</i>) and adjust RF gain manually, maximizing dynamic variability of received signals. As RF GAIN is advanced past -5 dB, a single bar on the S-meter starts at S-2 and moves upward as a reminder of how far gain has been reduced (-5 dB/unit).</p> <p>If desired, <i>MENU:RF GAIN</i> can be assigned to PFn (pg. 25) for quick access.</p> <p>Note 1: If you plan to turn AGC off as described above, you should set up the <i>MENU:AF LIM</i> parameter to avoid painful audio volume on strong signals.</p> <p>Note 2: RF gain is reset to -0 dB on power-up. Otherwise the operator might not be aware of a previous gain reduction used under different band conditions.</p>

		Note 3: As is the case with many software-defined transceivers, the KX2's RF GAIN control is actually an input scaling factor applied within the DSP itself. Reducing RF gain doesn't impact the strength of signals seen by the A-to-D converter (ADC; see glossary, pg. 63). Gain ahead of the ADC can only be reduced by turning the preamp off, and (if necessary) turning the attenuator on.
RS232	4800 b	This sets the RS232 (or USB) communications rate in bits per second (bps). During firmware download (via <i>KX2 Utility</i>), the baud rate is set automatically to 38400 baud. It is then restored to the value selected in this menu entry.
RTC ADJ	0	This parameter can be adjusted to improve the long-term accuracy of the real-time clock on the KXIO2 option. (<i>MENU:KXIO2</i> must be set to NOR to use the RTC.) Monitor your clock's accuracy over 24 hours, preferably at your typical ambient operating temperature. (The KX2 can be turned off during any portion of this monitor period, as long as an internal battery or external supply is attached.) If it's off by more than +/- 2 seconds per day, use RTC ADJ to compensate. For example, if it's slow by 5 seconds per day, set RTC ADJ to "-5 SEC". Allow a few hours, minimum, before making a further correction.
RX EQ	----- (+0 dB, each band)	Receiver audio graphic equalizer. VFO A is used as an 8-band bar graph, showing boost or cut (-16 dB to +16 dB in 1 dB increments) for each AF band. The 8 bands are 0.05, 0.1, 0.2, 0.4, 0.8, 1.6, 2.4 and 3.2 kHz. Tap 0-7 to select an AF band. VFO A selects boost/cut. Hold CLR to reset all bands to +0 dB. CW and SSB mode RX EQ are separate. Not applicable to DATA modes.
RXSBNUL 	GAIN nnn	Used to null (reject) the receiver's opposite-sideband image. If the menu name is <i>RXSBNL *</i> , then an extended per-band calibration procedure has been completed. Normally this is done at the factory. This procedure requires a 160-10 meter signal source (such as an Elecraft XG3); instructions are available on our website. Also see Receive Opposite Sideband calibration, pg. 38.
SER NUM	<S/N>	Your KX2's serial number, e.g. 05000 . Cannot be changed.
SW TEST 	OFF	To turn on switch test, rotate VFO A until the parameter becomes SCN ADC . Then hold any switch to see its scan row and column ADC reading.

SW TONE	ON	<p>If set to ON, switch presses generate audible feedback tones. If set to CODE nn, Morse code characters are generated at nn WPM on control activation. The normal DISP switch function (special displays) is not available in this case. Instead, a tap of DISP reads out the operating mode and frequency in kHz, e.g. “U 238” for USB on 7.238 MHz. (Plain-text description of the full Morse UI available on request.)</p> <p>Holding the APF/AN switch during power-on will also turn on Morse feedback.</p> <p>Switch tone volume is the same as CW sidetone volume. It must be adjusted in CW mode, using ☉ MON.</p> <p>Pitch of switch tones and Morse characters: In general, a <i>low-to-high</i> tone pair (or high-pitched Morse) is generated when a switch function is turned on, and <i>high-to-low</i> (or low-pitched Morse) when it is turned off. Some switches do not generate tones because they might interfere with received or transmitted audio.</p>
TECH MD	OFF	Set to ON to reveal Tech Mode menu entries (those marked with  in this list).
TIME	N/A	<p>Real-time-clock view/set. Tap 1 / 2 / 3 to set HH / MM / SS. To see the time and other displays during normal operation, tap DISP (see pg. 23). Time is only maintained if a KXIO2 option module and an internal battery are installed.</p> <p>Also see the RTC ADJ menu entry, which may be used to improve the long-term accuracy of the real-time clock.</p> <p>Note: The clock circuitry must be powered by the KX2’s internal battery or an attached power supply. Refer to the KXIO2 menu entry for details.</p>
TUN PWR	NOR	<p>If set to NOR, TUNE power level follows the POWER knob. Otherwise, the parameter sets a fixed power level (0-10 W) for TUNE, overriding the present POWER knob setting.</p> <p>Note: TUN PWR does not pertain to ATU TUNE, which uses 2 or 3 W (KXAT2) or 5 W (KXAT100).</p>
TX BIAS 	ppp qq	Transmit bias constants. See Transmit Bias , pg. 38.
TX CMP	0	<p>Transmit speech compression (SSB mode). A setting of 20 (dB) is a good compromise between SSB signal talk power (“punch”) and good fidelity. Set to 0 (default) when doing 2-tone IMD testing. Note: TX CMP is automatically set to 0 in audio data modes (DATA A and AFSK A).</p>

TXCRNUL 	1 nnnn	Used at the factory to null the transmit carrier on each band. See pg. 39.
TX DLY 	NOR 005	Varies the delay in milliseconds between key-down and RF output. This is useful with external power amplifiers having slow T/R relays. (Use NOR with the KXPA100 if there is no following higher-power amplifier.) There are two TX DLY settings: one for HF-10 m and the other for transverter bands. NOR (5 ms) is recommended in most cases. A delay of up to 20 ms can be set, but use the smallest delay possible since longer delays can add some timing variation in CW mode at higher code speeds.
TX EQ	+0 dB, each band	Transmit audio graphic equalizer (applies to SSB mode only). Functions the same as <i>RX EQ</i> , above. TX EQ can be adjusted during transmit. ⚠ Do not use high settings of TX EQ without carefully monitoring your signal. Most microphones, including the Elecraft MH3, will provide good audio quality with little or no TX EQ. High settings can cause distortion.
TX GAIN 	ALC nn	Shows whether transmit ALC (automatic level control) is enabled, along with the transmit gain constant for the present band (nn). The gain constant is updated whenever the TUNE function is used at exactly 6.0 W and SWR is 2.0:1 or lower. See Transmit Gain calibration procedure, pg. 38. If a KXPA100 amplifier is connected via the remote-control cable, <i>PA MODE</i> is ON, and PWR is 10 W or higher, the <i>TX GAIN</i> parameter shows the KX2 drive level for 75 W output at the KXPA100. If the drive value is preceded by the letter 'A', it was obtained from the KXPA100 (factory calibration value). If the drive value is preceded by the letter 't', it was obtained by doing P out CAL at 75 W at the KX2 itself (see <i>MENU:PA MODE</i>). Holding CLR will erase the KX2's CAL value on the present band, restoring the 'A' value (from the KXPA100). This menu entry is also used to turn transmit ALC on/off. It can be turned off for transmit testing purposes by tapping ATU while in this menu entry. (This is NOT necessary for any operational purpose. In all modes, ALC is optimized for low distortion.) When ALC is turned off, a (-) sign is added to the parameter, e.g. -ALC nn . Also, an asterisk is added to the PWR control value when it is being adjusted (e.g. 5.0 W*). With ALC off, the displayed power level will not change; the control functions as a fine power adjustment, and its effect must be observed

		with an external instrument.
TX GATE	OFF 0	The TX noise gate can be used to suppress transmitted audio below a certain level, e.g. that of an amplifier fan. Tap 1 within the <i>TX GATE</i> menu entry to turn the noise gate on/off. Use VFO A to set the desired threshold. Since there's no visual indication that transmit audio is below the threshold, you should adjust it using the transmit voice monitor (MON), ideally while using headphones. Set the threshold high enough to cut off transmit audio due to local noise, but not so high that it causes your voice to drop out too frequently.
TXSBNUL 	GAIN nnn	Set at factory to null transmit opposite sideband. See pg. 39.
VFO CRS	Per-mode	Tuning rate selection for VFO A and B when coarse tuning is selected (using RATE). Also applies to offset tuning of VFO A (via the OFS/B knob) when both RIT and XIT are turned off.
VOX DLY	0.00 (CW) 0.50 (SSB/data)	If VOX MD is set to ON in the current mode, this menu entry sets the VOX delay time in seconds (recovery time from transmit to receive). In CW mode, the default delay (0.00) also turns on the QSK icon, indicating the fastest possible break-in. (See <i>CW WGHT</i> menu entry for additional QSK settings.) Independent VOX delay times are saved in SSB and audio data modes (pg. 28).
VOX GN	030	Adjusts sensitivity of VOX to match your mic and voice. Set to trigger at normal speech level, but not in response to noise. Start with low settings (10-20).
VOX INH	000	Adjusts immunity of the VOX circuit to false triggering by speaker audio. (Also known as anti-vox.) A setting of about 30 is a good starting point. If receive audio from a speaker trips the vox, increase the setting.
VOX MD	ON (CW) OFF (SSB, AF data)	If VOX is OFF , transmit must be started by tapping XMIT (otherwise known as PTT, or push-to-talk operation). In CW mode, setting VOX MD to ON allows “hit-the-key” transmit. In SSB mode, VOX= ON allows transmit to start when you start speaking. In audio data modes, VOX starts transmit when a computer connected to the mic jack outputs an audio signal. VOX is always ON in PSK-D and FSK-D modes; PTT is not available. VOX cannot be used with the built-in microphone.
WATTMTR 	1.00	Wattmeter calibration parameter. If an external, known-accurate wattmeter reads

		<p>lower than the KX2's wattmeter, decrease the parameter value (and vice-versa). Internal wattmeter accuracy may vary by up to +/- 1 dB, per band.</p> <p>On transverter bands, the menu entry name changes to <i>WMTR XV</i>.</p>
XIT	OFF	<p>XIT is short for <i>Xmit Incremental Tuning</i>. Set to ON to offset the transmit frequency without affecting the receive frequency. The XIT icon will turn on. Use OFS/B to set the offset (+/- 9.999 kHz). This is also the offset that will be used with RIT (pg. 16). If you use XIT frequently, you may wish to assign it to PFn.</p> <p>XIT can be useful for applying a small offset to your transmit signal to improve copy by other stations, especially in PSK-D mode (such an offset must be determined experimentally). It can also be used as an alternative to SPLIT, leaving VFO B free for other purposes. For more on XIT and RIT, see pg. 16.</p>
XVn ON 	NO	Tap [1]–[7] to select the applicable transverter band display (1 - 7). Set parameter to YES to enable or NO to disable.
XVn RF 	144	Lower edge for transverter band <n> (1-7); 0-24999 MHz. (Tap [1]–[7] to select applicable transverter band.)
XVn IF 	28	Specify KX2 band to use as the I.F. for transverter band <n> (1-7). (Tap [1]–[7] to select the transverter band.) I.F. selections include 7, 14, 21, and 28 MHz.
XVn PWR 	H 0.1	Sets upper limit on power level in watts for XVTR band <n>. Tap [1]–[7] to select band. Note: The KX2 does not have a low-level transverter port, so transverters must have their own T/R switching and be able to handle the specified power level.
XVn OFS 	0.00	Offset (-9.99 to +9.99 kHz) for transverter band n (1-7). (Tap [1]–[7] to select band.) Compensates for oscillator/multiplier chain errors in external transverters.

Troubleshooting

The most common symptoms and their causes are listed below, in three categories (general, transmit, and receive). Most problems are related to control settings. If the problem persists, please contact Elecraft support (see pg. 67) or post a question on our email forum.

General

- **MCU LD shown on LCD, and TX LED flashing:** Do a forced firmware load (pg. 33).
- ****** shown on LCD permanently:** This may indicate that the KX2 did not power-down correctly. Disconnect power for a few seconds, then try a forced firmware load (pg. 33).
- **Display backlight turns on, but then turns off upon release of switches:** Disconnect all external equipment from the KX2. Verify power supply or battery voltage is between 8 and 15 V.
- **ERR nnn (error) message appears in the VFO B area:** Refer to **Error Messages** (pg. 57).
- **PA FLT** (power amplifier fault) message appears in the VFO B area: See KXPA100 owner's manual.
- **BAT LOW is flashed periodically:** Check the battery voltage (tap **DISP** and rotate OFS/B until the supply voltage display appears). If the batteries are at their normal voltage, you may have *MENU:BAT MIN* set to the wrong low-battery warning level. See this menu entry for recommendations.
- **Can't turn power on:** Check the power cable. If running from an internal battery, make sure it's charged.
- **Can't turn power off:** If the display remains on, or the unit is otherwise unresponsive, disconnect the power supply. (If an internal battery pack is in use, also remove the battery.) Allow 5-10 seconds, then reconnect power and try turning the unit on.
- **General problem with transmit and/or receive:** Many problems can be caused by low power supply voltage or by a noisy or intermittent supply. Check your power supply's on/off switch, voltage, fuses (if applicable), and DC cabling. The KX2 provides both voltage and current monitoring (pg. 23). Also see *Transmit* and *Receive* troubleshooting sections, below.
- **General problem with firmware behavior:** (1) Check all menu settings (see menu listings in the previous section). Hold **MENU** for about 3 seconds to see help information about each menu entry. (2) Try loading the latest KX2 firmware. Review the release notes for changes that may be related to your symptoms.
- **N/A message (Not Applicable):** The function you're trying to use does not apply in the present context.
- **Mode icon flashes:** This is a reminder that you're about to set the KX2 up for cross-mode SPLIT operation (VFOs in different modes). Tap any key to clear. To view and change VFO B's mode, tap **A / B**.
- **VFO A frequency doesn't change:** You may have the VFO locked. Tap **RATE** to unlock.

- **VFO A frequency changes by itself:** If using a mic other than the MH3, set *MIC BTN* to OFF.

Transmit

- **BND END:** Indicates an attempt to transmit outside the ham bands.
- **TX LED on all the time:** This could indicate that PTT is being held on by external equipment. Try disconnecting everything connected to the left side panel except the power supply. VOX gain (*VOX GN* menu entry) may be set too high.
- **HI CUR or HI SWR warning:** Check supply voltage. If voltage is low and/or a low-impedance antenna load is present, current can go up for a given requested power level. Reduce power if necessary. (The KX2 may do this automatically. If this doesn't reduce the current or reflected power to safe levels, the KX2 will drop out of transmit mode.)
- **HI TEMP warning:** PA heat sink temperature has exceeded the safe operating limit. Use **DISP** to check power supply voltage, current drain, and PA temperature. Allow heat sink to cool. Reduce power if necessary. (The KX2 may automatically reduce power, drop out of transmit mode, or turn itself off.)
- **KX2's right side panel is hot to the touch:** The right side is used as a heat sink, so it is normal for it to feel quite warm during long transmissions. The panel will run cooler if you use shorter transmissions, lower power, or a lower supply voltage. If operating in sunlight, try to orient the right side panel away from the sun.
- **An asterisk (*) appears in the PWR setting display (e.g. 5.0 W*):** Transmit ALC has been turned off. To turn it back on, go to *MENU:TX GAIN*, unlock the parameter by holding **FREQ** for 3 seconds, then tap **ATU**. This will turn off the (-) sign in front of **ALC**.
- **Can't transmit in CW mode:** (1) Make sure the key or keyer paddle is plugged into the correct jack. (2) To transmit immediately upon hitting the key, you must have VOX-CW enabled (see *MENU:VOX*). If VOX is off (PTT-CW), you must tap **XMIT** before sending; otherwise only a sidetone is generated. (3) You may be in **SPLIT** mode, with VFO B set for a voice or data mode. Tap **A/B** to check VFO B's mode.
- **Can't use the mic in voice modes:** You may be in **SPLIT** mode, with VFO B set for CW or data mode rather than a voice mode. Tap **A/B** to check VFO B's mode.
- **Low power output:** You may also be working into a high-SWR load and/or using a low supply voltage. Also try redoing **Transmit Gain** calibration (pg. 38). **Note:** Max power also varies per band.
- **Inadequate transmit carrier or opposite-sideband suppression:** The voice- and audio-data carrier and opposite sideband will typically be down 60 dB or more at 5 watts output. If either is significantly higher than this level, the **Transmit Carrier** or **Transmit Opposite Sideband** calibration steps (pg. 39) can be performed. These procedures require a spectrum analyzer and are normally done only at the factory.

Receive

- **HI RFI warning, preamp turns off, or RX icon turns on:** The KX2 protects itself from high received signal levels. First the preamp is turned off, if it was on. The second step taken by the KX2, if necessary, is to turn on the RF attenuator. The receive overload icon (**RX**), near the **ANT** icon, will turn on. Once signals return to a safe level for 5 seconds, the attenuator will be turned back off. Also see COR (next item).
- **Carrier-operated relay activated (a relay is heard, and the RX icon turns on):** The carrier-operated-relay (COR) may be activated due to the signal from a nearby transmitter. This is usually due to close proximity between your antenna and the other station's antenna. The COR is actually the relay for the present low-pass filter. When the relay opens, signals will drop by 40 to 60 dB, protecting the KX2. The relay will close again shortly after the signal drops. If the COR is being repeatedly activated, try moving the antennas farther apart. You can also increase the COR threshold, at your discretion; see *MENU:COR LVL*.
- **HI CUR warning:** May indicate that speaker volume is too high; gain is reduced by the KX2 in this case.
- **No received signal:** Check (1) antenna connectors; (2) RF gain too low (set RF gain menu entry fully clockwise, to **-0 dB**); (3) bandwidth too narrow (tap **FIL** and rotate AF GAIN/MON to widen the passband); (4) *MENU:REF CAL* parameter not adjusted properly.
- **Signals very weak below 3 MHz:** The KX2 is designed primarily for use on 80-10 meters (3 to 30 MHz). Receive capability extends down to 500 kHz, but as shown in the Specifications section, signals will be progressively attenuated below 3 MHz due to high-pass filtering in the T/R switch. (This filtering is intended to protect the T/R switch PIN diodes.) Attenuation will be approximately 15-20 dB in the 160-meter band, and much greater at the low end of the AM broadcast band. Sensitivity should still be adequate for reception of strong AM broadcast stations, useful in an emergency. Also see next item regarding mixer images in this range.
- **Signals in the 500 kHz-3 MHz range appear to be off-frequency:** These may be *mixer images* of signals higher up in frequency. They appear because the KX2 does not provide filtering below 3 MHz (see above). Generally, if an AM broadcast signal in the 550-1700 kHz range can be tuned in at an exact multiple of 10 kHz in LSB or USB mode, then it is a legitimate signal. Those tuning in at non-multiples of 10 kHz are likely to be images.
- **Received signal level too low:** (1) check headphone and speaker plugs and cables; (2) make sure that *MENU:RX EQ* has not been set for large cuts; (3) verify that *MENU:REF CAL* is properly adjusted; (4) make sure *MENU:RF GAIN* is set to -0 dB.
- **Spurious signals ("birdies"):** All receivers exhibit some birdies. Most will be inaudible with an antenna connected. In the KX2, there may be significant birdies or harmonics of birdies at the following frequencies due to internal signal sources: 16000 and 18432 +/- 5 kHz (MCU and DSP clock frequencies), 500-900 kHz

(DC-DC converter oscillators, CMOS RF switches). In the unlikely event that a birdie interferes with operation, try CW reverse (*MENU:ALT MD*), or auto-notch (**APF-AN** switch, SSB mode only).

- **Opposite-sideband images heard:** Opposite-sideband suppression is typically 50-60 dB. If images appear too high in amplitude, **Receive Opposite Sideband** suppression may have to be adjusted (normally done at the factory; see pg. 38).
- **“Frying pan” or buzzing sound in headphones:** Headphones may not be plugged in all the way.
- **Mobile installation noise:** If the 12 V DC accessory jack in a vehicle causes interference to the KX2’s receiver, improve filtering of the DC supply.
- **Low-level signals are heard that don’t change as the VFO is rotated:** It’s possible for extremely strong signals to create audible artifacts, due to AM detection at the mixer, that are not affected by tuning the VFO. If this occurs, first try turning off the preamp. If that doesn’t suffice, turn on the attenuator. If the source of such signals is a nearby transmitter (such as at Field Day), reorient or move antennas, or use an external band-pass filter.
- **KX2 VFO signal is heard in a nearby receiver:** A receiver whose antenna is in very close proximity to the KX2’s may pick up the KX2’s VFO signal when both are set to about the same frequency (+/- 8 kHz). Try separating or reorienting the antennas. If that isn’t possible, try turning on the preamp and/or attenuator at each radio. This will often improve isolation between the local oscillator and the antenna jack.
- **Internal speaker distortion at high volume:** The KX2’s small internal speaker is not intended for use in high-noise environments, such as in a noisy vehicle or outdoors in high winds. If audible artifacts occur, reduce AF gain or switch to headphones or an external speaker. (Stereo headphones or dual external speakers will allow the use of audio effects and dual watch.)

Parameter Initialization (EEINIT)

⚠ Parameter initialization should not be done without first consulting Elecraft customer support. We can help you solve most problems without taking this step. Also, please look for your symptoms in the Troubleshooting section above.

It is possible, though rare, for EEPROM parameters to become altered in such a way as to prevent the firmware from running correctly. If you suspect this, you can reinitialize parameters to defaults, then restore a previously-saved configuration (or re-do configuration steps manually; no test equipment is required). To initialize:

- **IMPORTANT:** Run the *KX2 Utility* program and use the **Save Configuration** function to save your present firmware configuration. **(Otherwise, you'll need to re-do calibration steps after EEINIT.)**
- Turn the KX2 off (using the KX2's on/off switch combination, not your power supply).
- Hold in the **NB** knob with your left hand. Then turn power on with your right hand by holding **RATE** and **A/B** together for about 3 seconds until the LEDs all turn on. Finally, release the **NB** knob after a few more seconds. You should see **EE INIT** on the LCD.
- When **EE INIT** completes, you may see **ERR nnn** due to initialization. Tap **DISP** to clear any error messages.
- Restore all parameters using the **Restore Configuration** function of the *KX2 Utility* program. Then turn power off and on again. See if the original problem has been resolved. If not, contact Elecraft. **Note:** Elecraft maintains configuration files for all KX2s sold. Your original configuration file can be sent to you via email on request.

Error Messages (ERR nnn)

Error messages may be displayed on VFO B at power-up or during normal operation. In many cases error messages are due to a problem with a single option module or incorrect firmware configuration.

⚠ Some error conditions suggest doing an EEINIT if other remedies fail. DO NOT DO AN EEINIT unless you have consulted Elecraft customer support.

If you see an error message on VFO B (ERR nnn): Write down the error message, as well as any associated error data shown on the VFO A display (e.g. **d=005**). Then tap any switch to clear the error code. Multiple errors may occur; in this case, write down each of the messages and VFO A data, if any, before you clear them.

See Error Message table below for details on specific **ERR** messages and associated data values, if any.

Error Msg	Problem	Troubleshooting steps
ERR ATC, ERR ATI	KXAT2 module not accessible: ATC = I/O expander C ATI = I/O address mismatch	If the module is not actually installed, set <i>MENU:ATUMD</i> to NOT INST . If the module is installed, remove it and re-install it, making sure the 8-pin connector is correctly lined up with its mating connector on the RF board.
ERR ATR	KXAT2 relay failure (on VFO A, d=nnn identifies the failing relay, e.g. 001 for relay K1)	Turn power off for 10 seconds, then back on. Remove and re-install the KXAT2 option module, making sure both of its connectors are correctly lined up with their mating connectors on the RF board. If this doesn't correct the problem, replace the module.
ERR DS1	No DSP SPI command echo	Turn power off for 10 seconds, then back on. Reload MCU and DSP firmware. If this doesn't correct the problem, <i>save your configuration using KX2 Utility</i> , then consult customer support to see if you should do an EEINIT (pg. 56). If this corrects the problem, restore your configuration using <i>KX2 Utility</i> . If error codes persist, write down all error codes and associated data values (displayed on VFO A) and contact Elecraft.
ERR DS2	DSP SPI echo not inverted	
ERR DSE, DSX	DSP command timeout. d=nnn is the last DSP command sent.	
ERR DSP	DSP, CODEC, or ADC power-up self-test failed	
ERR EE1	On-chip EEPROM read/write	The main microcontroller (MCU) may be defective.

	test failed	Follow the steps shown for ERR DS1.
ERR EE2	External EEPROM read/write test failed	EEPROM may be defective. This message may also appear if power is turned off/on too rapidly, or if the supply voltage “bounces” during turn-on. If the power supply is not at fault, follow steps shown for ERR DS1.
ERR FW2	General firmware problem. d=nnn identifies the type of error (report to Elecraft).	Follow steps shown for ERR DS1.
ERR IOA	RF board I/O expander unresponsive.	Turn power on. Reload MCU and DSP firmware. If error codes persist, turn power off, remove all option modules (KXAT2 and KXIO2), and turn power back on. Turn off associated option module enables in the menu (pg. 35), then turn power off and back on. If this corrects the problem, re-install the option modules one at a time to see which one may be causing the problem. If errors persist, the Control Panel or RF Board may have to be replaced. Write down error codes and data values (on VFO A) before contacting customer support.
ERR IO2	KXIO2 module error (real-time-clock). d=nnn is the specific error code (report to Elecraft).	Turn power off for 10 seconds, then back on. If this doesn't correct the problem, re-seat the KXIO2 module and repeat. If the problem persists, replace the KXIO2.
ERR KEY, ERR PTT	Attempt to key the transmitter or activate PTT during power-on sequence. (Note: If ERR PTT occurs, VOX transmit is disabled in all modes. Re-enable using <i>MENU:VOX</i> .)	Usually caused by an incorrect setting of <i>MENU:MIC BTN</i> for the current microphone, or an external device shorting the KEY or PTT line to ground, or a shorted KXPD2 (or KXPD3) keyer paddle. Turn power off, then disconnect the KXPD2 or KXPD3 (if applicable) and everything plugged into the left side panel, except for the power supply. Turn power back on. If the problem has disappeared, plug devices back in one at a time to see which one caused the error.
ERR OSC	Synthesizer IC unresponsive	Follow steps for ERR IOA.

ERR RFB	RF board may be disconnected from Control Panel board	Follow steps for ERR IOA.
ERR RFK	RF board relay failure (on VFO A, d=nnn identifies the failing relay, e.g. 001 for relay K1)	Follow steps for ERR IOA.
ERR TX6, ERR TX7	Transmit power MOSFET Q6 or Q7 bias out of range	Follow steps for ERR IOA.
ERR TXG	Transmit gain constant out of range	If this only occurs on one or two bands, there could be a problem with a band-pass or low-pass filter. Also try re-doing Transmit Gain calibration (pg. 38). If this doesn't correct the problem, reload a known-good Configuration file using the latest version of the <i>KX2 Utility</i> . Customer support can supply the original Configuration file if you didn't save one when you first received your KX2.
ERR TXC, ERR TXS	Transmit attempt without first calibrating TX BIAS in CW (TXC) or SSB (TXS) mode	Perform Transmit Bias calibration (pg. 38). This is a fully-automated procedure that requires no test equipment.
ERR TXN	Transmit attempt without first nulling the carrier on present band	Reload a known-good Configuration file using the latest version of the <i>KX2 Utility</i> . Customer support can supply the original Configuration file if you did not save a Configuration file when you first received your KX2.
ERR TXO	Transmit attempt without first nulling the opposite sideband on present band	
ERR TXP	Transmit attempt without first calibrating gain on present band	Follow steps for ERR TXC.
ERR TOS, ERR TPA	Power amplifier temperature sensor out of range	Follow steps for ERR IOA.
ERR VOX	VOX activation detected at power-on	Usually caused by audio at the mic at power-on, with VOX enabled for voice modes. Turn power off, then disconnect the mic. Turn power back on. Turn voice-mode VOX off or reduce VOX gain.

Theory Of Operation

This section includes a functional description of the KX2's RF, control panel (CP), and option boards; a block diagram; and a glossary of selected technical terms. Also see the KX2 FAQ (www.elecraft.com).

RF Board

The RF board contains all of the KX2's RF circuitry as well as low-level baseband (AF) stages in the receive path.

The relay-switched **low pass filters** are used during both transmit and receive. The signal on the antenna side of the filters pass through a forward/reflected power and SWR bridge to the antenna jack (BNC), or to the optional KXAT2 automatic antenna tuner. Latching relays are used to minimize power consumption. **Transmit/receive** (T/R) switching splits the common signal path from the antenna and low pass filters to either the transmitter power amp or receiver input. T/R switching uses PIN diodes and CMOS switches for clean, silent transitions.

The **RF band-pass filters** are used for both transmit and receive. Filters are selected with PIN diodes. The band pass filters significantly attenuate receive signals at harmonics of the RX frequency, particularly the odd harmonics. Following the band pass filters and T/R switching are the **RF preamplifier** and an **attenuator**. These provide various tradeoffs between overall receive gain and noise figure (or MDS).

The **RX mixer** converts the RF signal to quadrature (8 kHz IF I and Q signals), which are low-pass filtered and amplified before being passed to the CP board for analog to digital conversion (ADC).

The **TX AF Amp and TX mixer** block converts baseband (AF I and Q) modulating signals to an RF signal which is then routed to the T/R switching and band pass filters. This signal provides excitation to the 10 W power amplifier (PA). The PA uses a pair of RF power MOSFETs. Temperature monitoring of the MOSFETS allows automatic reduction of power if they become too hot during long transmit periods.

The optional **KXAT2 automatic antenna tuner** (ATU) option connects between the BNC antenna jack and the RF board's SWR/power bridge and low pass filters. It uses a latching relay-switched "L network" with seven inductors and seven capacitors capable of matching a wide range of antenna impedances. The **KXIO2** option incorporates a **real-time clock** (RTC) function, useful for logging and time-keeping. It also has two general-purpose outputs that can be used to turn on relays, etc., in external gear. These are open-drain outputs (the drain lead of a MOSFET transistor). They act like contact closures to ground.

Control Panel (CP) Board

The CP (Control Panel) circuit board contains all of the KX2's control circuitry as well as IF and AF stages for the transmit and receive paths. It contains two on-board microcontrollers: one to manage the radio (MCU), and another to process all transmit and receive signals digitally (DSP).

The synthesized, digitally controlled **local oscillator** (LO) provides quadrature signals to the transmit and receive mixers.

The **DSP** is a 32-bit, floating-point device. All modulation, demodulation, AGC, filtering, equalizing, and other signal processing functions are handled by this IC.

The incoming IF signal from the RF board is provided in low-level phase quadrature, or **In-phase** and **Quadrature** (I/Q). These signals are digitized by a very low power, high-performance analog-to-digital converter (ADC), then passed to the DSP for processing.

The baseband transmit signal is likewise provided in I/Q format to the RF board. A dedicated, high-performance **digital-to-analog converter** (DAC) is used to generate a very clean transmitted signal.

DSP program storage is by means of a 2 megabyte **FLASH memory** device. This IC also provides storage of operator messages for the DVR function.

Stereo (two-channel) audio from the DSP is converted to analog signals for use with headphones or dual external speakers (PHONES jack). The use of stereo allows special processing to help reduce operator fatigue (**audio effects**), and also optimizes **dual watch** capability, where the signals from VFOs A and B are routed to the left and right audio channels. If the internal speaker is used, the audio is monophonic, and is boosted by a separate speaker amplifier IC. Microphone audio (or low level audio from a computer or other source) uses another ADC that runs at all times to enable voice-operated transmit (VOX) operation.

The **microcontroller unit** (MCU) handles all user interface functions for the KX2, including 12 switches and 4 shaft encoders. It also handles timing, sequencing, and overall management of the radio. The MCU uses EEPROM to store operator preferences, messages, and settings. An accessory port (**ACC**) provides a **serial I/O** interface between the MCU and an attached personal computer (PC), with both RS232 and USB cabling options.

The MCU uses two industry-standard **serial protocols** to control circuitry on the CP and RF boards. **I²C** (pronounced I-squared-C) controls the synthesizer IC. An **SPI** bus handles bandswitching, changeover between receive and transmit, etc. The driver for the **liquid-crystal display** (LCD) is also controlled via the I²C port.

KX2 Block Diagram

W. Burdick, L. Johnson, R. Heineck, R. Friess

Rev: 02 May 2016

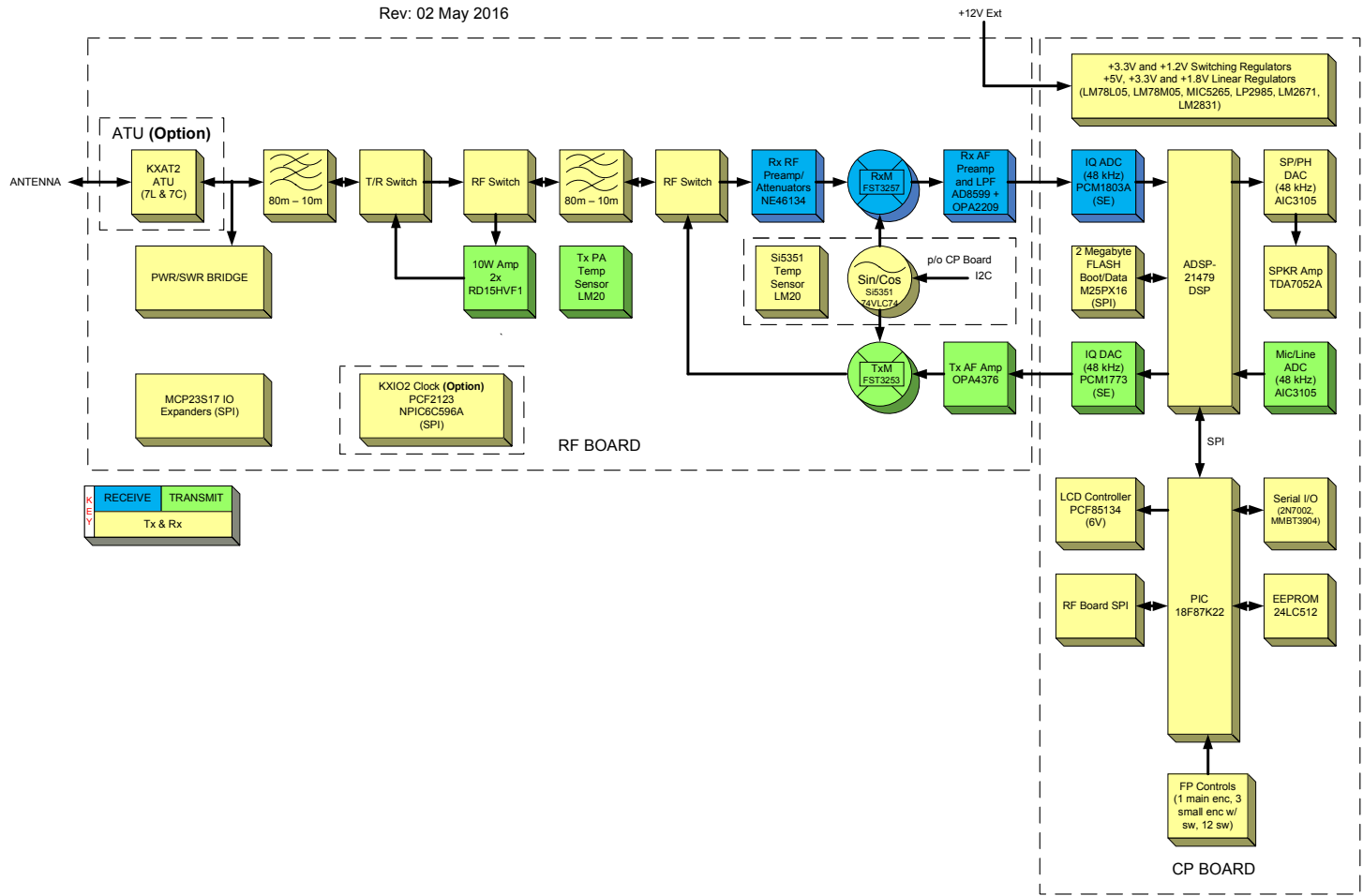

Glossary of Selected Terms

The following terms are often used in the discussion of amateur radio transceivers and related equipment. All are applicable to the KX2, used here to illustrate some of the concepts. Also see the *ARRL Handbook*.

A-to-D or ADC (analog-to-digital converter): An integrated circuit that converts analog signals such as audio or RF into digital form. Digital signals can then be processed by a digital signal processor, or *DSP* (see below).

AF, RF, and IF: AF stands for *audio frequencies*—usually, sounds that you can hear. RF, or radio frequencies, are the actual frequencies of the radio signals (or TV, or cell phone, etc.). IF, or intermediate frequencies, are generally somewhere between RF and AF. In a receiver, it is usually advantageous to convert RF signals to a lower IF at which is it more practical to obtain gain or selectivity. These IF signals are then further converted to AF and amplified further so they can be used to drive headphones or speakers.

Attenuator: A circuit that reduces signals to a safe level for use by subsequent stages in a receiver or transmitter. The KX2's receiver includes a switchable attenuator (pg. 17).

ATU (automatic antenna tuner): A device inserted between a transmitter (or transceiver) and an antenna that establishes an optimal match between the two, thus allowing full power transfer. (See KXAT2, pg. 32.)

D-to-A or DAC (digital-to-analog converter): An integrated circuit that converts digital signals into analog form, such as audio or RF. Also see *DSP*, below.

dB (decibel): A measure of signal increase or decrease, or of one signal relative to another signal. In human terms, one dB represents a “just noticeable difference” between two signals. Mathematically, dB is derived from the logarithm of the ratio of two signals. Receivers must handle signals over a huge range—in excess of 100 dB. *dBm* is a more specific term that means “dB relative to 1 milliwatt” (1 mW) of power. 1 mW is thus “0 dBm.”

DC-to-DC converter: A device that converts one DC voltage into another. For example, the KX2 includes a very efficient DC-to-DC converter that converts 12 V (nominal) at the DC input jack to 3.3 V for use by its low-voltage circuitry. The advantage of a DC-DC converter is that when it steps voltage down, it steps current up (or vice-versa). In this case, the 300 mA the KX2 consumes at 3.3 V might require only 100 mA at the 12 V power source.

DSP (digital signal processor): A highly specialized numeric computer, implemented on a single integrated circuit, that processes signals digitally. Inputs *to* the DSP must generally be converted from analog to digital form (see *A-to-D*, above), while outputs *from* the DSP must be converted from digital to analog (see *D-to-A*). Use of DSP

techniques can result in greater versatility and smaller size compared to the equivalent analog circuitry. The KX2 uses a very advanced, power-efficient DSP.

ESD (electrostatic discharge): An event during which high voltages or currents appear within a radio or other electronic device, potentially causing damage. Antennas, control cables, or the operator's body are all potential ESD sources. Damage can be avoided through proper handling and grounding techniques.

HF (high-frequency): Signals in the range of 3 to 30 MHz. In amateur radio, *HF* is usually shorthand for *160-10 meters* (1.8 to 29.7 MHz), or the "HF bands." 160 meters actually falls in the *MF* range (0.3 to 3 MHz).

IMD (intermodulation distortion): Unwanted signal products that are created in the various stages of a receiver or transmitter. If all stages were entirely "clean," there would be no IMD. In reality, every stage contributes some distortion, with the amount of distortion being proportional to signal level. Radio designers go to great lengths to minimize distortion, trading off circuit cost and complexity against the benefit of reduced interference.

Keyer: A device that partially automates the sending of Morse code, allowing for faster code speeds. The KX2 has a built-in keyer function, as well as an optional attached *keyer paddle* (KXPD2 or KXPD3, pg. 32).

MCU (microcontroller unit): A computer or controller usually integrated onto a single integrated circuit. A modern amateur transceiver usually has one main MCU that controls most radio functions. It may have other smaller MCUs or *co-processors* that perform specific functions. The DSP in the KX2 is a specialized co-processor (see DSP, above).

MDS (minimum discernable signal): A measure of a radio's sensitivity, expressed in dB (decibels) relative to 1 milliwatt (0 *dBm*). For example, the user of a KX2 with the 20 dB *preamp* turned on, can typically copy a CW signal at about -137 dBm, or 137 dB *below* 1 milliwatt. MDS is dependent on the receiver bandwidth, with 500 Hz normally used for standardized measurements.

Preamp: A *pre*-amplifier that increases RF signals to a higher level for use by subsequent stages in a receiver. A preamp is generally designed to contribute little noise of its own, so that it improves the noise figure of the radio (also see *MDS*).

SDR (software-defined radio): A radio that performs signal modulation, demodulation, filtering, and other functions in software. Such software can execute internally (in a dedicated DSP IC, as in the Elecraft K3S, KX3, or KX2) or externally (in a general-purpose computer, as required with "black box" SDRs).

VFO (variable frequency oscillator): A signal source used to select a radio's operating frequency. The KX2's large knob controls VFO A, while a smaller knob controls VFO B (see Using VFOs A and B, pg. 16).

Specifications

GENERAL

Frequency Range	Receive, 500 kHz - 32 MHz. See 500 kHz to 3 MHz sensitivity note below. Transmit, 80/60/40/30/20/17/15/12/10 meter ham bands. (Consult factory for MARS or other non-ham-band coverage.) Transmit excluded in some ranges (by country).
Frequency Stability	+/- 1 ppm typical at 25 C after 5-minute warm-up.
Antenna	50 ohms, BNC
Modes	USB, LSB, CW, DATA; built-in text encode/decode for CW/PSK/RTTY modes
VFOs	Dual VFOs; 150+ frequency memories; scanning/channel hopping
Accessory I/O	ACC: RS232 or USB port depending on selected adapter. Keyline: 30 V max (pg. 9). AUX 1 and 2 (KXIO2): Open-drain outputs; 28 V, 150 mA max.
Supply Voltage and Current	8 V min, 15 V max. 1 to 2 A typical in transmit; 150 mA typical in receive (backlight off, preamp off, no signal).
Size and Weight	Size, less projections: 2.8 x 5.8 x 1.6" (5 x 14.7 x 4 cm); weight, less battery or options: 13 oz. (0.37 kg)

RECEIVER*

Sensitivity (MDS), 500-Hz bandwidth	-136 dBm (typ.), preamp on. Note: Sensitivity rolls off significantly below 3.0 MHz due to protective high-pass filtering. Preamp-on MDS is typically -105 dBm at 1.5 MHz, and -80 dBm at 1.0 MHz, sufficient for emergency AM broadcast signal copy.
Image and I.F. Rejection	55-70 dB typ. From 3 to 32 MHz (varies with filter settings, mode, and band). Image rejection from 0.5 to 3.0 MHz is not specified.
Audio Output	Internal speaker, 0.3 W typ.; headphones/ext. speaker jack, 0.1 W/channel (stereo)
Receive Features	8 band RX EQ, tunable I.F. passband width/shift, audio peaking filter (APF), noise reduction, noise blanker, automatic notch filter

TRANSMITTER*

Output Power	80-17 meters, 10 W PEP max (+/- 1 dB); 12 and 10 meters, 8 W PEP max (+/- 1 dB). Recommended transmit duty cycle: 50%, all modes. (If power amplifier temperature or current drain is too high, power will automatically be reduced.) NOTE: When using over 5 W in SSB, DATA-A and AFSK-A modes, the recommended supply voltage is 12 V or higher to minimize transmit intermodulation products. Higher power with lower voltages should be used only when necessary.
Internal ATU (KXAT2)	7 L/7 C network; matching range typ. 20:1 or higher. Rated power: 15 W. Insertion loss (bypass mode): < 0.5 dB.
Transmit Features	Adjustable speech compression (baseband envelope clipping); 8-band TX EQ; VOX; full and semi CW break-in with adjustable delay; diode T/R Switching; 3 DATA/CW messages and 2 SSB (DVR) messages
Carrier Suppression	> 50 dB typ.
Harmonic / Spurious Outputs	> 50 dB below carrier typ. @ 10 W
CW Sidetone/Transmit offset	400-800 Hz, adjustable (receive filter center frequency tracks sidetone pitch)

* Specifications apply only within ham bands except as noted. All measurements taken with 13.8 VDC supply.

Customer Service and Support

Technical Assistance

Technical assistance is available to all of our customers. We encourage you to use email for faster response to your questions. Email address is: support@elecraft.com. We typically respond to email the same day from Monday through Friday.

If you need replacement parts, send an e-mail to parts@elecraft.com.

Telephone assistance is available from 9 A.M. to 5 P.M. Pacific time (weekdays only) at 831-763-4211. For faster response, please use e-mail rather than calling the factory.

Repair / Alignment Service

If necessary, you may return your Elecraft product to us for repair, calibration or alignment. If you purchased your Elecraft product from one of our Authorized Distributors, please contact them first. They can perform all of the factory calibrations that can be made at the factory.

IMPORTANT:

(1) REMOVE BATTERIES before shipping (see instructions on pg. 6).

(2) You must contact Elecraft before mailing your product to obtain Return Authorization to begin the return process. When emailing, please provide your call sign, the product in question, and a description of what the problem is. We will reply with an email that contains shipping instructions, and current information on repair fees and turn-around times. Our repair location may be different from our factory location. We will give you the address to ship your KX2 to at the time of repair authorization. Packages shipped to Aptos without authorization will incur an additional shipping charge for reshipment from Aptos to our repair depot

Elecraft 1-Year Limited Warranty

This warranty is effective as of the date of first consumer purchase (or if shipped from the factory, the date the product is shipped to the customer). It covers both our kits and fully assembled products. For kits, before requesting warranty service, you should fully complete the assembly, carefully following all instructions in the manual.

Who is covered: This warranty covers the original owner of the Elecraft product as disclosed to Elecraft at the time of order. Elecraft products transferred by the purchaser to a third party, either by sale, gift, or other method, who is not disclosed to Elecraft at the time of original order, are not covered by this warranty. If the Elecraft product is being bought indirectly for a third party, the third party's name and address must be provided at time of order to ensure warranty coverage.

What is covered: During the first year after date of purchase, Elecraft will replace defective or missing parts free of charge (post-paid). We will also correct any malfunction to kits or assembled units caused by defective parts and materials. Purchaser pays inbound shipping to us for warranty repair; we pay shipping to return the repaired equipment to you by UPS ground service or equivalent to the continental USA and Canada. For Alaska, Hawaii, and other destinations outside the U.S. and Canada, actual return shipping cost is paid by the owner.

What is not covered: This warranty does not cover correction of kit assembly errors. It also does not cover misalignment; repair of damage caused by misuse, negligence, battery leakage or corrosion, or builder modifications; or any performance malfunctions involving non-Elecraft accessory equipment. The use of acid-core solder, water-soluble flux solder, or any corrosive or conductive flux or solvent will void this warranty in its entirety. Also not covered is reimbursement for loss of use, inconvenience, customer assembly or alignment time, or cost of unauthorized service.

Limitation of incidental or consequential damages: This warranty does not extend to non-Elecraft equipment or components used in conjunction with our products. Any such repair or replacement is the responsibility of the customer. Elecraft will not be liable for any special, indirect, incidental or consequential damages, including but not limited to any loss of business or profits.

Index

ACC Jack, 9
Advanced Operating Features, 23
AF Gain Control, 17
AF Limiter, 40
AFSK A Mode, 28
AFV, 23
AFX (Audio Effects), 25
AGC MD, 40
AGC Speed, 41
AGC Threshold, 41
ALC, 49
ALT MD, 15, 41
Amp Hour Metering, 7, 23, 42
Analog To Digital Converter (ADC, A-to-D), 63
Antenna, 11, 38
Antenna Control (Auto-Info), 34
Antenna Switch (KXAT100), 42
Antennas, 10
Anti-VOX, 20
Attenuator, 17, 63
ATU Tuning, 19
Audio Effects (AFX), 25, 40
Audio Peaking Filter (APF), 18
Auto Info (AI Mode), 42
Auto Power-Off, 35
Automatic Antenna Tuner (ATU), 11, 19, 42, 63

Auto-Notch, 18
Auto-off, 43
Auto-Spot, 21
AUX Outputs, 9, 43
Backlight, 43
Band Selection, 15
Banner, Power-On, 30
Batteries, 43
Battery Installation, 6
Battery Warning Level, 43
Birdies, 54
Break-In Keying (QSK), 20, 21
Calibration Procedures, 37
Carrier-Operated Relay, 43
Channel Hopping, 24
Clipboard Mount, 7
Clock, 48
Coarse Tuning Rate, 50
Code Practice, 21
Configuration, 35, 56
Control Groups, 5
Counterpoise Wire, 7
Cross-Mode Operation, 30
Customer Support, 67
CW Keying Weight, 21, 30, 44
CW Mode, 21

CW Reverse, 15, 41
 CW, Break-In (QSK), 20, 21
 CW, Sending in SSB mode, 44
 CWT, 18, 21, 44
 CW-to-DATA, 21
 DATA Mode, 28
 Data Modes, 27
 dB, decibel, 63
 dBV, 23
 DC-to-DC converter, 63
 Digital Signal Processor (DSP), 63
 Digital To Analog Converter (DAC, D-to-A), 63
 Digital Voice Recorder, 30
 Direct Frequency Entry, 15
 Display (LCD), 13
 Dual Watch, 25, 44
 EEINIT, 56
 Electrostatic Discharge (ESD), 64
 Error Messages (ERR nnn), 52, 57
 Filter Center Frequency, 66
 Filter Graphic, 13
 Filter Passband Control, 17
 Firmware Revision, 33, 45
 Firmware Upgrades, 33
 Forcing a Firmware Download, 33
 Frequency Memories, 24
 Frequency Memory Editor, 34
 Frequency Range, 65
 Frequency Stability, 65
 Front Panel, 5
 FSK D Mode, 27, 28
 Glossary, 63
 Headphones, 8
 HI CUR Warning, 53, 54
 HI RFI Warning, 54
 HI SWR Warning, 53
 High Frequency (HF), 64
 Iambic Keying, 35, 43
 Intermodulation Distortion (IMD), 64
 Keyboard, 34
 Keyer, 19, 64
 Keyer Paddle, 8, 44
 Keying Weight, 21, 44
 KX2 Utility PC Application, 33, 34, 56
 KXAT2, 32, 35
 KXIO2, 45
 KXPA100, 19, 35, 46
 LCD Backlight, 43
 LCD Test, 45
 LED Brightness, 45
 Limiter, 40
 Low Battery Warning, 35, 52
 Memories, 24
 Memory Label, 24
 Menu Functions, 40
 Menu Settings, 14, 35
 Message Record/Play, 22
 Message Repeat, 45
 MH3, 32
 Mic Bias, 45

Mic Function Buttons, 45
Microcontroller Unit (MCU), 64
Microphone, 8
Microphone Gain Control, 19, 20
Microphone Settings, 36
Microphone, Internal, 8, 20
Minimum Discernable Signal (MDS), 64
Mode Selection, 15
Noise Blanker, 18
Noise Reduction, 18
Notch Filtering, 13
Operation, 14
Option Module Enables, 35
Options, 32
PA temperature, 23
Parameter Initialization, 56
Parameter Save/Restore, 57, 58
PFn, 25
PGM, 9
Power On/Off, 14
Power Output Control, 19
Power Supply, 5
Preamp, 13, 17, 64
Programmable Function Switch, 25
PSK D Mode, 28
PSK31, 28
QSK, 20, 21, 44
Quasi-Stereo (AFX), 40
Quick Memories, 24
Quick-Start Guide, 12
Real Time Clock, 36
Receive Settings, 17
Reference Oscillator, 37, 46
Remote Control, 34
RF Board, 60
RF Gain Control, 46
RIT/XIT Offset, 16
RS232, 34, 47
RTC, 7, 36, 45
RTC Adjustment, 47
RTTY, 28
RX EQ, 26, 47, 49, 54
Scanning, 24
Self-Test, 33
Serial Number, 47
Sideband Selection, 41
Sidetone, 21, 46
Software Defined Radio (SDR), 64
Speaker, 8, 25
Specifications, 65
Speech Compression, 48
SPLIT and Cross-Mode Operation, 53
Split Operation, 29
Squelch Control, 17
SSB +CW, 44
SSB Mode, 20
SSB/CW VFO Offset, 26
Standing Wave Ratio (SWR), 11
Switch Test, 47
Switch Tones, 36, 48

Tech Mode Menu Entries, 48
Terminal Emulator, 34
Text Decode and Display, 21, 29
Theory Of Operation, 60
Time, 36
Transmit Bias, 48
Transmit Gain Calibration, 38, 49
Transmit Metering, 20
Transmit Noise Gate, 30, 50
Transmit Settings, 19
Transverter, 31
Transverter Control, 51
Troubleshooting, 52
Tune Power, 36, 48
Tuning Rate, VFO, 36, 50
TX EQ, 26, 49
TX Gain, 49
TX LED, 33, 53
Variable Frequency Oscillator (VFO), 64
VFO B Parameter Displays, 16, 23
VFO lock, 16
VFO Setup, 36
VFO Tuning Controls, 16, 36, 50
VOX Delay, 50
VOX Gain, 50
VOX Inhibit, 50
VOX Mode, 50
VOX Setup, 20
VOX, Voice Modes, 36
Warranty, 68
Wattmeter, 50
XIT, 51